

*ELETRÔNICA*

*SUPER*



*OM*

**CATÁLOGO DE PRODUTOS  
MARÇO / ABRIL 2014**

**Fone: (14) 3203-4188  
E-mail: [esupersom@esupersom.com.br](mailto:esupersom@esupersom.com.br)  
Skype: [esupersom@hotmail.com](https://www.hotmail.com)**

# ÍNDICE

A	C	M			
ABRÇAÇADEIRAS DE NYLON	1	CIRCUITO INTEGRADO	34	MICROFONE	29
ADAPTADORES PARA BOCAIS	1	COLA	31	MINI CONTROLES DE TV	5
ADAPTADORES, PLUGUES E EMENDAS	19	CONECTOR DE TORÇAO	2	MOTOR COMUM	29
ALARMES E ANUNCIADORES	1	CONECTOR PORCELANA	2	MOTORES	32
ÁLCOOL ISOPROPÍLICO	30	CONECTOR TERMOPLÁSTICO EM BARRA	2	MULTÍMETROS	29
ALTO FALANTES	19	CONNECTORES	25	<b>P</b>	
ANTENAS	1, 18,19	CONTROLES REMOTOS	5	PONTAS DE PROVA	29
APARELHO DE TESTE PARA CONTROLES REMOTOS	5	CONTROLES REMOTOS TV's LCD/PLASMA	8	PORTA FUSÍVEL	28
<b>B</b>		COOLERS E VENTUINHAS	27	POTENCIÔMETROS	31
BALLON E CACHIMBOS	22	CRISTAL	27	PRODUTOS ORBI	30
BASES PARA LÂMPADAS	2	<b>D</b>		PROTOBOARD	29
BATERIAS	22	DIODOS	27, 32	REFLETORES	3
BICO SUGADOR	29	DIVISORES	25	<b>R</b>	
BOCAIS DE BAQUELITE	1	<b>E</b>		RELÉS	29
BOCAIS DE PORCELANA	1	ESPAGUETES TERMO-RETRÁTEIS	4	RELÉS	32
BOCAL TERMOPLÁSTICO	2	<b>F</b>		RESISTORES	34 A 36
BORNES	22	FERRAMENTAS	28	<b>S</b>	
BUCHAS TEFLON	31	FITAS ISOLANTES	2	SOLDAS	29
<b>C</b>		FIXA CABOS MIGUELÃO	31	SOQUETE PARA CI.COM.T EM OURO TORNEADO	34
CABOS DIVERSOS	22	FONTES	28	SOQUETE PARA CI ESTAMPADO	34
CABOS FLAT	24	FORNOS MICROONDAS - ACESSÓRIOS	32	SUGADORES DE SOLDA	29
CAPACITOR CERÂMICO	32	FUSISTORES	34	SUPORTE FERRO SOLDA	30
CAPACITOR CERÂMICO DISCO ALTA ISOLAÇÃO	32	FUSÍVEIS	28,32	SUPORTE PARA LED	27
CAPACITOR CERÂMICO DISCO POLYESTER ESP.	32	FUSÍVEIS TÉRMICOS	28	SUPORTES P/ TV's E ANTENAS	3
CAPACITOR POLYESTER	32	<b>G</b>		<b>T</b>	
CAPACITOR POLYESTER AXIAL MULTI-CAMADAS	32	GARRA JACARÉ	28	TELEFONIA- ACESSÓRIOS	30
CAPACITORES DE FORNOS	32	GRAXA SILICONE	30	TEMPORIZADORES	4
CAPACITORES ELETROLÍTICOS 85°/105°	33	<b>J</b>		TERMINAIS DIVERSOS	4
CAPACITORES ELETROLÍTICOS BIPOLARES	33	JACKS	21	TRANSF. P/ LÂMPADAS DICRÓICAS	3
CAPACITORES ELETROLÍTICOS SMD	34	<b>L</b>		TRANSISTORES	34
CAPACITORES POLYPROPILENO	34	LÂMPADAS DIVERSAS	29	TRIMMER MURATA	31
CAPAS	25	LIMPA CONTATOS	30	TWEETER	19
CARREGADOR	25	LOCALIZADOR DE SATÉLITES	29	<b>V</b>	
CHAVE SELETORA	25	LUBRIFICANTES	30	VARISTOR	30
CHAVES DIVERSAS	25,32	LUMINÁRIAS DIVERSAS	2		
CHOQUE MICRO INDUTOR	27	LUZ DIVERTIDA LED	3		
		LUZ GUIA LED	3		
		LUZ NOTURNA LED	3		

## CONDIÇÕES DE VENDA

- 1) Preço sujeito a reajuste sem prévio aviso.
- 2) Reservamos o direito de alterar, ou não as condições de pagamento.
- 3) O pedido somente será liberado se não houver títulos em atraso, na ocasião da entrega.
- 4) Frete e risco por conta do destinatário.
- 5) Pedido mínimo: R\$300,00. Faturamento mínimo por compra R\$ 450,00.
- 6) Os novos clientes devem enviar junto com o pedido cópia do contrato social, últimas alterações contratuais, cartão do CNPJ e três referências comerciais.

## POLÍTICA DE TROCA E GARANTIA

- Ø Não fazemos trocas referentes a compra "errada" ou "arrepentida".
  - Ø Somente aceitamos troca de Luminárias, Antenas e Refletores com embalagem em perfeito estado.
  - Ø Componentes eletrônicos, tais como: CI's, Transistores, Placas c/circuito, Varicap's, etc... "NAO HA GARANTIA".
  - Ø Membranas para forno, teclados para TV's, Máquinas e Controle remoto, "3 MESES DE GARANTIA", à partir da data da compra.
  - Ø Ressalvamos o direito da não troca por uso indevido ou danificação do mesmo no transporte de devoluções.
- Nos demais itens do catálogo, favor entrar em contato com nossos vendedores para que possam orientá-los.

**Obs: Para quantidades menores que as determinadas para cada oferta, o preço de venda será o mesmo que o último preço divulgado antes de o produto entrar em oferta. Caso tenha dúvidas, por gentileza, consulte o departamento de vendas!**

LISTA DE PREÇOS VÁLIDA DE 01/03/2014 A 31/03/2014

**ATENÇÃO: ESTA LISTA DE PREÇOS APRESENTA A MAIOR PARTE DO NOSSO MIX DE PRODUTOS. PORÉM, LEMBRAMOS QUE TEMOS UMA LISTA DE SALDOS CONTENDO DIVERSAS MEMBRANAS, POTENCIÔMETROS ENTRE OUTROS ITENS. PARA MAIORES INFORMAÇÕES, ENTRE EM CONTATO COM A ELETRÔNICA SUPERSOM LTDA PELO TELEFONE (014) 3203-4188 OU EMAIL [esupersom@esupersom.com.br](mailto:esupersom@esupersom.com.br)**

# NOVIDADES MARÇO/ABRIL -2014

## ALICATE



1140 ALICATE AMPERÍMETRO 44.00

## CABOS



1125 CABO MINI USB 2.0 P/ CAMERA DIGITAL 1.8MTS 4.00



1143 CABO TRIPOLAR 2P+T 0.75MM 1.5M 11.00



1109 CABO DE FORÇA TRIPOLAR 2P+T 90° 3 X0.75MM 1.5MT 14.00

## CHAVES



1112 CHAVE GANGORRA MINI 3 POSIÇÕES 1.60



1113 CHAVE GANGORRA MINI PRETA 1.50

1114 CHAVE GANGORRA MINI BRANCA 1.50



1115 CHAVE LIGA/DESLIGA 15A/125V 10A/250V 2 TERMINAIS 1.60



1116 CHAVE LIGA/DESLIGA 15A/30A 250V KCD4 PRETA 2.00



1117 CHAVE LIGA/DESLIGA FCD1 110V 1.50



1118 CHAVE GANGORRA LIGA/DESLIGA 10A 250V PT 2.30



1119 CHAVE LIGA/DESLIGA KCD3 2 TERMINAIS VM 2.50



1120 CHAVE POWER LIGA/DESLIGA VM KCD1-106 6A 250V 2.50



1122 CHAVE GANGORRA LIGA/DESLIGA KCD3-11 16A/250V 1.50



1123 CHAVE TIC TAC UNIVERSAL PUXADOR 6.00

## EMENDAS



1124 EMENDA "T" JACK F 3.00

## CONTROLES REMOTOS



9915 CCE/ BLUE SKY 2004 5.20



9914 ELSYS DUOMAX 5.20



PARA TV SAMSUNG 14" E 20" / 29" E 34"

9913 SAMSUNG TV 6.00



PARA HOME THEATER AH59-02298A

9912 SAMSUNG HOME THEATER. MOD.: AH59-02298A 14.00

## FONTES



1128 FONTE UNIVERSAL REGULÁVEL 2.5A 30W PST-30MA 75.00



1129 FONTE UNIVERSAL REGULÁVEL 3A 30W PST-30MB 85.00



1130 FONTE 5V 2A 20.00

1131 FONTE 6V 1A 14.00

1132 FONTE 6V 2A 20.00

## PLUGUES



1136 PLUG ADAPTADOR 2P+T PADRÃO ANTIGO X NOVO 5.70



1137 PLUG DE FORÇA DESMONTÁVEL 90° 2P 10A X 250V 3.00



1138 PLUG 2P BENJAMIM 10A 250V 4.80



1139 TOMADA DESMONTÁVEL 2P 10A 250V 3.50



1134 PLUG RCA PLÁSTICO PRETO 0.50

1135 PLUG RCA PLÁSTICO VERMELHO 0.50

## SPEAKON



1133 SPEAKON 8 VIAS FEMEA REDONDO 3.50

## EXTENSÃO E FILTRO DE LINHA



1110 EXTENSÃO 6 TOMADAS 3X0.75MM 2P+T 10A 250V 18.00



1111 4 TOMADAS 2P+T 3X0.75MM 22.00

1112 6 TOMADAS 2P+T 1.5MT 3X0.75MM 24.00

ELETRÔNICA SUPERSOM LTDA



\*Pedido mínimo: R\$300.00 (a vista) R\$450.00 (a prazo)

## ABRAÇADEIRAS DE NYLON



Consulte o site para abraçadeiras coloridas

9203	ABN25103 2,5 X 100MM (BR) (100PC)	<u>2.02</u>
9204	ABN25106 2,5 X 100MM (PT) (100PC)	<u>2.02</u>
9205	ABN25143 2,5 X 140MM (BR) (100PC)	<u>2.96</u>
9206	ABN25146 2,5 X 140MM (PT) (100PCS)	<u>2.96</u>
9198	ABN25153 2,5 X 150MM (BR) (100PCS)	<u>3.30</u>
9199	ABN25156 2,5 X 150MM (PT) (100PCS)	<u>3.30</u>
9207	ABN25203 2,5 X 200MM (BR) (100PCS)	<u>4.26</u>
9208	ABN25206 2,5 X 200MM (PT) (100PCS)	<u>4.26</u>
9209	ABN35143 3,5 X 140MM (BR) (100PCS)	<u>4.94</u>
9210	ABN35146 3,5 X 140MM (PT) (100PCS)	<u>4.94</u>
9211	ABN35203 3,5 X 200MM (BR) (100PCS)	<u>6.90</u>
9212	ABN35206 3,5 X 200MM (PT) (100PCS)	<u>6.90</u>
9213	ABN35283 3,5 X 280MM (BR) (100PCS)	<u>9.90</u>
9214	ABN35286 3,5 X 280MM (PT) (100PCS)	<u>9.90</u>
9215	ABN45203 4,5 X 200MM (BR) (100PCS)	<u>9.00</u>
9216	ABN45206 4,5 X 200MM (PT) (100PCS)	<u>9.00</u>
9217	ABN45283 4,5 X 280MM (BR) (100PCS)	<u>13.26</u>
9218	ABN45286 4,5 X 280MM (PT) (100PCS)	<u>13.26</u>
9219	ABN47383 4,7 X 380MM (BR) (50PCS)	<u>9.64</u>
9220	ABN47386 4,7 X 380MM (PT) (50PCS)	<u>9.64</u>
9221	ABN67373 6,7 X 370MM (BR) (50PCS)	<u>15.28</u>
9222	ABN67376 6,7 X 370MM (PT) (50PCS)	<u>15.28</u>
9230	ABN90766 9,0 X 760MM (PT) (50PCS)	<u>53.34</u>
9231	ABN90920 9,0 X 920MM (PT) (50PCS)	<u>62.66</u>
9241	ABN91156 9,0 X 1150MM (PT) (25PCS)	<u>42.62</u>
9244	ABN91356 9,0 X 1350MM (PT) (25PCS)	<u>53.42</u>
9245	ABN93546 12,0 X 540MM (PT) (25PCS)	<u>33.26</u>

Consulte o site para abraçadeiras coloridas

## ALARMES E ANUNCIADORES



9272 ALARME E ANUNCIADOR - 2 EM 1 90DB AJA10111 3.78



2010 ANUNCIADOR DE PRESENÇA E ALARME ANA20111 18.04

## ANTENAS



9254 ANT.INT.P/TV MINI PARAB. CIRCULAR 80CM- 5 SEC. ATV11508 13.38



9255 AI 5 SEC. A1V21508 JCM- 13.16



1121 ANT.INTERNA P/TV TIPO "V" 70CM- 4 SEÇÕES ATV31407 3.42

9253 ANT.INT.P/TV TIPO "V" 80CM- 5 SEÇÕES ATV31508 3.84



9271 ANT.INT.P/TV TIPO "V" 80CM- 5 SEÇÕES C/CH.SELETORA ATV41508 7.32



4743 ANTENA EXTERNA PARA TV MODELO FISH ATV50103 53.64



4745 ANTENA EXTERNA PARA TV MODELO FLAT ATV50104 61.24

## ADAPTADORES PARA BOCAIS



9927 PORCELANA E-27 X E-40 BRANCO APB27403 4.88



9928 PORCELANA E-40 X E-27 BRANCO APB40273 3.22

## BOCAIS DE BAQUELITE



9415 E-27 BBQ27053 (MIN.20 PCS) 2.00



9416 E-27 BBQ27063 (MIN.12 PCS) 1.10

## BOCAIS DE PORCELANA



9437 E-14 BPO14033 FIXO DE TETO (MIN.25 PCS) 1.14



9486 E-27 BPO27023 INCL/DESMONT (MIN.10 PCS) 2.76



9417 E-27 BPO27033 FIXO DE TETO (MIN.10 PCS) 2.00



9418 E-27 BPO27063 PARA PLAFONIER (MIN.25 PCS) 1.36



9419 E-27 BPO27093 REFORÇADO (MIN.25 PCS) 1.88



9420 E-27 BPO27113 PARA SPOT (MIN.25 PCS) 1.16



9421 E-27 BPO27123 PARA SPOT C/ ALÇA (MIN.25 PCS) 0.82



9487 E-27 BPO27133 DUPLO CHANFRADO (MIN.25 PCS) 1.12



9488 E-27 BPO27143 DUPLO CHANFRADO C/ RAB (MIN.25 PCS) 1.18





9422 E-27 BPO27153 DE TEMPO (MIN.10 PCS) **3.24**



9423 E-40 BPO40063 LISO (MIN.10 PCS) **4.60**

### BASES PARA LÂMPADAS



9424 BASE P/ LÂMPADAS AR70 BPL11112 **2.74**



BASE P/ LÂMPADAS DICRÓICAS G5.3  
BPL12112 **0.84**



BASE P/ LÂMPADAS DICRÓICAS GZ10  
BPL13112 **1.86**

### CONECTOR TERMOPLÁSTICO EM BARRA



MÍNIMO 10 PÇS POR MODELO

9350	4MM² TRANSLÚCIDO CTB10420	<b>1.34</b>
9351	6MM² TRANSLÚCIDO CTB10620	<b>1.56</b>
9353	10MM² PRETO CTB11016	<b>2.50</b>
9352	10MM² TRANSLÚCIDO CTB11010	<b>2.50</b>
9354	16MM² PRETO CTB11610	<b>4.83</b>
9355	16MM² TRANSLÚCIDO CTB11616	<b>4.83</b>
9496	25MM² PRETO CTB12516	<b>8.50</b>
9497	25MM² TRANSLÚCIDO CTB12510	<b>8.50</b>

### CONECTOR DE TORÇÃO (PCT C/ 100PCS)



9356	CTE10629 4,0-6,0MM² 29MM C/ BORDA VM	<b>15.54</b>
9357	CTE11022 2,5-10,0MM² 22MM C/ BORDA AM	<b>11.64</b>
9358	CTE20115 0,5-10,0MM² 15MM S/ BORDA CZ	<b>6.32</b>

9359	CTE20218 0,5-2,5MM² 18MM S/ BORDA AZ	<b>7.28</b>
9360	CTE20423 1,0-4,0MM² 23MM S/ BORDA LJ	<b>9.24</b>
9361	CTE20624 1,0-6,0MM² 24,2MM S/ BORDA AM	<b>11.64</b>
9362	CTE21027 2,5-10,0MM² 27,8MM S/ BORDA VM	<b>14.56</b>

### FITAS ISOLANTES DE PVC ANTICHAMAS



19MM X 0.15MM X 5 METROS

1942 AM	AMARELA- FIS15051	<b>1.00</b>
1942 AZ	AZUL - FIS15052	<b>1.00</b>
1942 BR	BRANCA - FIS15053	<b>1.00</b>
1942 CZ	CINZA - FIS15054	<b>1.00</b>
1942 PT	PRETA - FIS15056	<b>1.00</b>
1942 VD	VERDE - FIS15057	<b>1.00</b>
1942 VM	VERMELHA - FIS15058	<b>1.00</b>

19MM X 0.15MM X 10 METROS

1943 AM	AMARELA- FIS15101	<b>1.68</b>
1943 AZ	AZUL - FIS15102	<b>1.68</b>
1943 BR	BRANCA - FIS15103	<b>1.68</b>
1943 CZ	CINZA - FIS15104	<b>1.68</b>
1943 PT	PRETA - FIS15106	<b>1.68</b>
1943 VD	VERDE - FIS15107	<b>1.68</b>
1943 VM	VERMELHA - FIS15108	<b>1.68</b>

19MM X 0.15MM X 20 METROS

8026	PRETA - FIS15206	<b>3.08</b>
------	------------------	-------------

### POTES DE FITAS ISOLANTES PRETAS DE PVC ANTICHAMAS



9273	19MM X0,15MM X 5MTS (POTE C/50PCS) FIS25056	<b>58.46</b>
9274	19MM X0,15MM X 10MTS (POTE C/36PCS) FIS25106	<b>75.22</b>
9275	19MM X0,15MM X 20MTS (POTE C/24PCS) FIS25206	<b>87.38</b>

### LUMINÁRIAS BLINDADAS



9498	655 X 85 X 93,5 MM - LBF11120 -1x20W	<b>35.44</b>
9499	1270 X 85 X 93,5 MM - LBF11140- 1x40W	<b>50.56</b>
9501	1565 X 85 X 93,5 MM - LBF11158- 1x58W	<b>61.34</b>
9504	655 X 131 X 93,5 MM - LBF11220- 2X20W	<b>40.98</b>
9505	1270 X 131 X 93,5 MM - LBF11240- 2X40W	<b>66.58</b>
9506	1565 X 131 X 93,5 MM - LBF11258- 2X58W	<b>83.10</b>

### LUMINÁRIAS DE MESA ARTICULÁVEL



COM BASE - 60W ROSCA E-27

9276	LMA10111 - AZUL CLARO	<b>40.42</b>
9277	LMA10112 AZUL	<b>40.42</b>
9298	LMA10113 BRANCA	<b>40.42</b>
9299	LMA10114 CINZA	<b>40.42</b>
9300	LMA10116 PRETA	<b>40.42</b>
9301	LMA10117 VERDE	<b>40.42</b>
9302	LMA10118 VERMELHA	<b>40.42</b>



COM GARRA - 60W ROSCA E-27

9304	LMA20113 BRANCA	<b>40.42</b>
9305	LMA20116 PRETA	<b>40.42</b>

### LUMINÁRIAS ESPETO DE JARDIM



9315	E-27 100W LJE20116 PT	<b>15.74</b>
9316	E-27 120W LJE20117 VD	<b>16.42</b>

### LUMINÁRIAS DE MESA FLEX



COM BASE - 60W ROSCA E-27

9309	LMF10112 AZUL	<b>23.46</b>
9310	LMF10113 BRANCA	<b>23.46</b>
9311	LMF10114 CINZA	<b>23.46</b>
9312	LMF10116 PRETA	<b>23.46</b>
9313	LMF10117 VERDE	<b>23.46</b>
9314	LMF10118 VERMELHA	<b>23.46</b>



COM GARRA - 60W ROSCA E-27

9306	LMF20113 BRANCA	<b>23.46</b>
9307	LMF20116 PRETA	<b>23.46</b>

### LUMINÁRIA DE MESA PELICANO



9455	127V AMARELA LPE10911	<b>21.78</b>
9456	127V AZUL LPE10912	<b>21.78</b>
9457	127V BRANCA LPE10913	<b>21.78</b>
9458	127V CINZA LPE10914	<b>21.78</b>
9461	127V PRETA LPE10916	<b>21.78</b>
9459	127V VERDE LPE10917	<b>21.78</b>
9460	127V VERMELHO LPE10918	<b>21.78</b>
9462	220V AMARELA LPE20911	<b>21.78</b>
9463	220V AZUL LPE20912	<b>21.78</b>
9464	220V BRANCA LPE20913	<b>21.78</b>
9465	220V CINZA LPE20914	<b>21.78</b>
9466	220V PRETA LPE20916	<b>21.78</b>
9467	220V VERDE LPE20917	<b>21.78</b>
9468	220V VERMELHA LPE20918	<b>21.78</b>

### LUZ NOTURNA LED



9317	LNL11103 0,4W X 127V BRANCA	11.30
9318	LNL11201 0,4W X 127V MULTICOLOR	11.30
9319	LNL21103 0,4W X 220V BRANCA	11.30
9320	LNL21201 0,4W X 220V MULTICOLOR	11.30

### LUZ DIVERTIDA LED



#### MODELOS AUTOVOLT

9323	LDL30111 GATO	4.64
9325	LDL30112 LEÃO	4.64
9327	LDL30113 OVELHA	4.64
9329	LDL30114 PINGUIM	4.64
9332	LDL30115 SAPO	4.64
9333	LDL30116 URSO	4.64

### LUZ GUIA LED



9321	LUZ GUIA 1W BIVOLT LGL30111 BRANCA	3.46
------	------------------------------------	------

### REFLETORES



9337	REFL. EXT ASSIMÉTRICO RDS11013 150W BR	78.80
9338	REFL. EXT ASSIMÉTRICO RDS11016 150W PT	78.80

### REFLETORES P/ LÂMP HALÓGENAS



#### AUTOVOLT

9339	RLH10153 150W BRANCO	16.04
9340	RLH10156 150W PRETO	16.04
9341	RLH10503 300/500W BRANCO	24.18
9342	RLH10506 300/500W PRETO	24.18
9343	RLH11003 1000W BRANCO	46.52
9344	RLH11006 1000W PRETO	46.52



#### AUTOVOLT. COM SENSOR

9482	RLH20153 150W 78MM BRANCO	45.16
9483	RLH20156 150W 78MM PRETO	45.16
9484	RLH20503 500W 118MM BRANCO	52.24
9485	RLH20506 500W 118MM PRETO	52.24

### SUPORTES



4750	SUPORTE PARA ANTENA EXTERNA DE TV SUP22111	15.08
------	--------------------------------------------	-------



4741	ACIMA DE 20 PEÇAS: R\$13.50/UNIDADE SUPORTE FIXO PARA TV E MONITOR 10" A 72" SUP52111	17.28
------	------------------------------------------------------------------------------------------	-------

### TRANSFORMADORES P/ LÂMPADAS DICRÓICAS



9522	50WX127V - TLD15011	8.62
9523	50WX220V- TLD25011	8.62

# ELETRÔNICA

## SUPER



## OM

## TEMPORIZADORES



### AUTOVOLT

9345 PLUG ANALÓGICO TMP10111 **21.92**



### AUTOVOLT

9346 PLUG DIGITAL TMP10211 **42.38**



### AUTOVOLT

9347 BARRAMENTO ANALÓGICO TMP20111 **20.00**



### AUTOVOLT

9348 BARRAMENTO DIGITAL TMP20211 **43.82**



9349 TRILHO 220V DIGITAL TMP32211 **59.02**

## TERMINAIS DE COMPRESSÃO



### 1 FURO

9363	TCC11001 1,5MM² (PCT C/100PCS)	<b>19.68</b>
9364	TCC11002 2,5MM² (PCT C/100PCS)	<b>20.82</b>
9365	TCC11004 4MM² (PCT C/100PCS)	<b>25.42</b>
9366	TCC11006 6MM² (PCT C/100PCS)	<b>28.66</b>
9367	TCC11010 10MM² (PCT C/100PCS)	<b>36.38</b>
9368	TCC11016 16MM² (PCT C/50PCS)	<b>25.30</b>
9369	TCC11025 25MM² (PCT C/50PCS)	<b>35.00</b>
9370	TCC11035 35MM² (PCT C/50PCS)	<b>44.16</b>
9371	TCC11050 50MM² (PCT C/50PCS)	<b>73.64</b>
9372	TCC11070 70MM² (PCT C/50PCS)	<b>102.50</b>
9373	TCC11095 95MM² (PCT C/10PCS)	<b>37.42</b>
9374	TCC11120 120MM² (PCT C/10PCS)	<b>50.76</b>
9489	TCC11150 150MM² (PCT C/10PCS)	<b>71.68</b>
9490	TCC11185 185MM² (PCT C/10PCS)	<b>108.12</b>
9491	TCC11240 240MM² (PCT C/10PCS)	<b>147.58</b>
9492	TCC11300 300MM² (PCT C/10PCS)	<b>222.14</b>

## TERMINAIS PRÉ-ISOLADOS

### TIPO ANEL - PACOTE COM 100 PCS



9385	TPA10103 0,5-1,5MM 3,7MM	<b>8.42</b>
9386	TPA10104 0,5-1,5MM-4,3MM	<b>9.48</b>
9387	TPA10105 0,5-1,5MM 5,3MM	<b>10.20</b>
9388	TPA10106 0,5-1,5MM 6,5MM	<b>12.46</b>
9389	TPA10108 0,5-1,5MM 8,4MM	<b>12.96</b>
9390	TPA10203 1,5-2,5MM 3,7MM	<b>11.92</b>

9391	TPA10204 1,5-2,5MM 4,3MM	<b>12.08</b>
9392	TPA10205 1,5-2,5MM 5,3MM	<b>11.80</b>
9393	TPA10206 1,5-2,5MM 6,5MM	<b>13.90</b>
9394	TPA10208 1,5-2,5MM 8,4MM	<b>14.56</b>
9395	TPA10603 4,0-6,0MM 3,7MM	<b>18.38</b>
9396	TPA10604 4,0-6,0MM 4,3MM	<b>20.80</b>
9397	TPA10605 4,0-6,0MM 5,3MM	<b>21.62</b>
9398	TPA10606 4,0-6,0MM 6,5MM	<b>25.64</b>
9399	TPA10608 4,0-6,0MM 8,4MM	<b>29.00</b>
9400	TPA10610 4,0-6,0MM 10,5MM	<b>29.44</b>

### TIPO EMENDA - PACOTE COM 100 PCS



9381	TPE10126 0,5-1,5MM 26,0MM VM	<b>12.96</b>
9382	TPE10226 1,5-2,5MM 26,0MM AZ	<b>15.56</b>
9383	TPE10626 4,0-6,0MM 26,0MM AM	<b>23.80</b>
9384	TPE11032 6,0-10MM 32,0MM VM	<b>62.44</b>

### TIPO FÊMEA - PACOTE COM 100 PCS



9375	TPF10121 0,5-1,5MM 21,0MM	<b>9.40</b>
9376	TPF10221 1,5-2,5MM 21MM	<b>9.90</b>
9377	TPF10625 4,0-6,0MM 25,0MM	<b>12.42</b>

### TIPO GARFO - PACOTE COM 100 PCS



9401	TPG10103 0,5-1,5MM 3,7MM	<b>7.44</b>
9402	TPG10104 0,5-1,5MM 4,3MM	<b>7.90</b>
9403	TPG10203 1,5-2,5MM 3,7MM	<b>9.82</b>
9404	TPG10204 1,5-2,5MM 4,3MM	<b>10.00</b>
9405	TPG10205 1,5-2,5MM 5,3MM	<b>9.94</b>
9406	TPG10604 4,0-6,0MM 4,3MM	<b>19.58</b>
9407	TPG10605 4,0-6,0MM 5,3MM	<b>21.26</b>

### TIPO MACHO - PACOTE COM 100 PCS



9378	TPM10121 0,5-1,5MM 21,0MM	<b>10.08</b>
9379	TPM10221 1,5-2,5MM 21,0MM	<b>10.26</b>
9380	TPM10625 4,0-6,0MM 25,0MM	<b>13.96</b>

### TIPO PINO - PACOTE COM 100 PCS



9408	TPP10120 0,5-1,5MM 20,0MM	<b>8.62</b>
9409	TPP10123 0,5-1,5MM 23,0MM	<b>9.16</b>
9410	TPP10220 1,5-2,5MM 20,0MM	<b>9.72</b>
9411	TPP10223 1,5-2,5MM 23,0MM	<b>10.48</b>
9412	TPP10625 4,0-6,0MM 25,5MM	<b>22.24</b>

### TIPO TUBO - PACOTE COM 100 PCS



9524	TPT10014 - 0,75MM	<b>2.26</b>
9525	TPT10114 - 1,0MM	<b>2.30</b>
9526	TPT10116 - 1,50MM	<b>2.62</b>
9527	TPT10215 - 2,50MM	<b>3.00</b>
9528	TPT10419 - 4,00MM	<b>5.10</b>
9529	TPT10620 - 6,00MM	<b>6.36</b>
6981	TPT11027 - 10,00MM	<b>11.98</b>
5307	TPT11628 - 16,00MM	<b>15.00</b>
9530	TPT12529 - 25,00MM	<b>17.22</b>

## ESPAGUETES TERMO-RETRATEIS

### NORMAL ENCOLHIDO

DIÂM.	ESPESSURA	DIÂM.	ESPESSURA
1,0MM	0,20MM	1,0MM	0,35MM
1,5MM	0,20MM	1,5MM	0,44MM
2,5MM	0,20MM	2,5MM	0,44MM
3,0MM	0,25MM	3,0MM	0,44MM
4,5MM	0,25MM	4,5MM	0,56MM
6,0MM	0,25MM	6,0MM	0,56MM
9,0MM	0,25MM	9,0MM	0,56MM
12,0MM	0,25MM	12,0MM	0,45MM
18,0MM	0,35MM	18,0MM	0,77MM



### ESPAGUETE PRETO - PACOTE COM 10 METROS

6751	1,0MM (PCTE C/10MTS)	<b>7.30</b>
6752	1,5MM (PCTE C/10MTS)	<b>7.40</b>
6753	2,5MM (PCTE C/10MTS)	<b>8.50</b>
6754	3,0MM (PCTE C/10MTS)	<b>8.70</b>
6755	4,5MM (PCTE C/10MTS)	<b>12.80</b>
6756	6,0MM (PCTE C/10MTS)	<b>15.85</b>
6757	9,0MM (PCTE C/10MTS)	<b>19.50</b>
6758	12,0MM (PCTE C/10MTS)	<b>25.50</b>
6759	18,0MM (PCTE C/10MTS)	<b>30.00</b>
6760	25,0MM (PCTE C/10MTS)	<b>60.00</b>

### ESPAGUETE PRETO - ROLO

7679	1,0MM (RL C/200MTS)	<b>98.00</b>
7680	1,5MM (RL C/200MTS)	<b>100.00</b>
7681	2,5MM (RL C/200MTS)	<b>115.00</b>
7682	3,0MM (RL C/200MTS)	<b>125.00</b>
7683	4,5MM (RL C/100MTS)	<b>85.00</b>
7684	6,0MM (RL C/100MTS)	<b>105.00</b>
7685	9,0MM (RL C/100MTS)	<b>130.00</b>
7686	12,0MM (RL C/100MTS)	<b>170.00</b>
7687	18,0MM (RL C/50MTS)	<b>195.00</b>
7688	25,0MM (RL C/50MTS)	<b>270.00</b>

### ESPAGUETE TRANSPARENTE - PCTE COM 10 METROS

6761	1,0MM (PCTE C/10MTS)	<b>4.30</b>
6762	1,5MM (PCTE C/10MTS)	<b>4.40</b>
6763	2,5MM (PCTE C/10MTS)	<b>5.10</b>
6764	3,0MM (PCTE C/10MTS)	<b>5.20</b>
6765	4,5MM (PCTE C/10MTS)	<b>6.00</b>
6766	6,0MM (PCTE C/10MTS)	<b>7.50</b>
6767	9,0MM (PCTE C/10MTS)	<b>10.00</b>
6768	12,0MM (PCTE C/10MTS)	<b>14.40</b>
6769	18,0MM (PCTE C/10MTS)	<b>24.40</b>
6770	25,0MM (PCTE C/10MTS)	<b>33.20</b>

### ESPAGUETE TRANSPARENTE - ROLO

7689	1,0MM (RL C/200MTS)	<b>66.90</b>
7690	1,5MM (RL C/200MTS)	<b>69.50</b>
7691	2,5MM (RL C/200MTS)	<b>80.00</b>
7692	3,0MM (RL C/200MTS)	<b>80.70</b>
7693	4,5MM (RL C/200MTS)	<b>95.70</b>
7694	6,0MM (RL C/100MTS)	<b>58.80</b>
7695	9,0MM (RL C/100MTS)	<b>80.00</b>
7696	12,0MM (RL C/100MTS)	<b>116.90</b>
7697	18,0MM (RL C/50MTS)	<b>97.50</b>
7698	25,0MM (RL C/50MTS)	<b>131.50</b>



### ESPAGUETE COLORIDO \* - PCTE COM 10 METROS

6771	1,0MM (PCTE C/10MTS)	<b>4.30</b>
6772	1,5MM (PCTE C/10MTS)	<b>4.40</b>
6773	2,5MM (PCTE C/10MTS)	<b>5.10</b>
6774	3,0MM (PCTE C/10MTS)	<b>5.20</b>
6775	4,5MM (PCTE C/10MTS)	<b>6.00</b>
6776	6,0MM (PCTE C/10MTS)	<b>7.50</b>
6777	9,0MM (PCTE C/10MTS)	<b>10.00</b>
7742	12,0MM (PCTE C/10MTS)	<b>14.40</b>
7743	18,0MM (PCTE C/10MTS)	<b>24.40</b>
7744	25,0MM (PCTE C/10MTS)	<b>33.20</b>

### ESPAGUETE COLORIDO \* - ROLO

7699	1,0MM (RL C/200MTS)	<b>66.90</b>
7700	1,5MM (RL C/200MTS)	<b>69.50</b>
7701	2,5MM (RL C/200MTS)	<b>80.00</b>
7702	3,0MM (RL C/200MTS)	<b>80.70</b>
7703	4,5MM (RL C/200MTS)	<b>95.70</b>
7704	6,0MM (RL C/100MTS)	<b>58.80</b>
7705	9,0MM (RL C/100MTS)	<b>80.00</b>
7706	12,0MM (RL C/100MTS)	<b>116.90</b>
7707	18,0MM (RL C/50MTS)	<b>97.50</b>
7708	25,0MM (RL C/50MTS)	<b>131.50</b>

\* PARA ESPAGUETES COLORIDOS, COLOCAR O CÓDIGO SEGUIDO DA COR: AZUL (AZ)/ AMARELO (AM)/ BRANCO (BR)/ VERMELHO (VM)/ VERDE (VD).



## MINI CONTROLES DE TV

QTDE MÍN.: 10 PÇS POR MODELO



8270 8272 8274 8162 8164 8276 8278 8166 8168 8170

8270	LG/GOLDSTAR	1.00	8162	PHILCO	1.00	8278	SANYO	1.00
8272	mitsubishi	1.00	8164	PHILIPS	1.00	8166	SEMP TOSHIBA	1.00
8274	PANASONIC	1.00	8276	SAMSUNG	1.00	8168	SHARP	1.00
						8170	SONY	1.00

## APARELHO DE TESTE PARA C.R



APARELHO DE TESTE P/ CONTROLE REMOTO ATRAVÉS DE EMISSÃO DE LUZ E SOM (SOM DIFERENCIADO PARA CADA FREQUÊNCIA EMITIDA). ALIMENTAÇÃO: FONTE DE 12V.

8373	COM FONTE	28.00
8374	SEM FONTE	20.00

## CONTROLES REMOTOS - SOM



P/MICRO-SYSTEMS DOS TIPOS: C/1 CD, CARROSSEL C/3 CD'S, ETC. QTDE MÍN. 10 PÇS.



8233 AIWA. MOD.: RC-TN450EX 1.00



P/MICRO-SYSTEMS DOS TIPOS: C/1 CD, CARROSSEL C/3 CDS, INCLUSIVE OS COM FUNÇÃO "KARAOKE", ETC. QTDE MÍN. 10 PÇS.



8235 AIWA. MOD.: RC-TN999 1.00



P/ ÁUDIO. QTDE MÍN. 10 PÇS.



8752 CCE. MOD.: LX-15 1.00



P/ MICRO-SYSTEMS GA-400V "VERSÃO VERMELHA". QTDE MÍN. 10 PÇS.



9087 GRADIENTE. MOD.: GA-400V 1.00

## AUTOMOTIVOS



PCD-210. QTDE MÍN. 10 PÇS.



8770 PHILCO. MOD.: PCR-64 1.00



P/ MICRO-SYSTEM. QTDE MÍN. 10 PÇS.



7485 GRADIENTE. MOD.: LS-90 1.00



COMPATÍVEL COM OS MODELOS:

AKB36638215 / MCD504 / MCS504F / MCS704F / MCS704W / MCS904F / MCS904S / MCS904S / MCT704 / MCV904

9985 LG. MOD.: AKB36638215 7.00



8875



8876



8877



8878

P/ TOCA-CD DE AUTO (DE TODOS OS MODELOS DESTA MARCA). QTDE MÍN.: 10 PÇS POR MODELO

8875	ALPINE. MOD.: RUE-4182	1.00
8876	KENWOOD. MOD.: RC-505	1.00
8877	PIONNER. MOD.: CXC-3173	1.00
8878	SONY. MOD.: RM-X114	1.00

## CONTROLE REMOTOS - DVD



P/ DVD AMVOX

9997 AMVOX. MOD.: AMD275 5.90



9135 BRITÂNIA. MOD. MATRIX PLUS 4.64



9138 BRITÂNIA. MOD. IMAGE A 4.64



DVD FAMA 3

9993 BRITÂNIA. MOD.: FAMA 3 5.80





BRITANIA. MOD.: THEATER FAMA 3

9983



CCE DVD

5.00



GRADIENTE. MOD.: D-10

4.30

QTDE MÍN. 10 PÇS.



GRADIENTE. MOD.: D-10

1.00



GRADIENTE. MOD.: D-10/2

8467

QTDE MÍN. 10 PÇS.



GRADIENTE. MOD.: D-12

1.00

QTDE MÍN. 10 PÇS.



GRADIENTE. MOD.: K-30

1.00

QTDE MÍN. 10 PÇS.



GRADIENTE. MOD.: D-461

1.00

D-461/ D-470/ D-680/ DT-350. QTDE MÍN. 10 PÇS



GRADIENTE. MOD.: D-202

9136

4.54



GRADIENTE HT500/HTS-520

1.00



LG. MOD.: 5722N

8471

P/ MODELOS DE DVD'S LG. QTDE MÍN. 10 PÇS.

5.24



DVD MAGNAVOX

9999

6.00

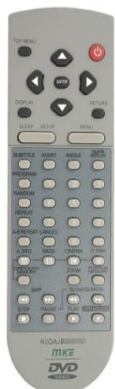

PANASONIC. MOD.: N2QAJB000050

8473

RV32BR E OUTROS

5.24



PHILCO. MOD.: PCR101

9974

5.70



PHILIPS. MOD.: DVD-615

8600

4.46

RC615



PHILIPS. MOD.: RC720-DVD-715. COR PRETA

8477

1.00

PHILIPS. MOD.: RC720 283207. COR PRATA

8479

1.00

RC703/ 711/715/ 720. QTD MÍN.: 10 PCS





9918 PHILIPS. MOD.: RC2K12



5.70 9917 PHILIPS. MOD.: CR1521/3355



5.70 9225 SAMSUNG. MOD.: 00011E

P240/P241/ P243/ P250/  
P255/ P355/ ETC



4.64 8487 TOSHIBA. MOD.: SER-0049 1.00

P/ TODA LINHA DE  
DVD'S DESTA MARCA.  
TIPO: SD6081 VK/  
6072/ 7063SLX/ ETC



9226 SONY. MOD.: RMT-D165A

P/ TODOS OS DVD'S  
DESTA MARCA. "POR  
TEREM OS MESMOS  
SINAIS DE  
FREQUÊNCIA"



4.74 8493 SVA. MOD.: RME-H1

D-1822.  
QTDE MÍN.: 10 PCS



1.00 8495 SVA. MOD.: RM-2018

D-2018 C/  
KARAOKÊ.  
QTDE MÍN.: 10  
PCS



1.00 8608 SVA. MOD.: RM-1300

D-1000/D-1018  
QTDE MÍN.: 10  
PCS



### CONTROLE REMOTOS - PARABÓLICAS



9919 RECEPTOR UNIVERSAL. MOD.:  
F-21



6.20 7393 CENTURY. MOD.: SS-071A

SUBSTITUI  
MODELOS USR-  
1900 E USR-1850

3.54



8682 CENTURY. MOD.: USR-1900

USR1850/  
USR1900

3.56



8756 CENTURY. MOD.: USR-1950

USR-1950  
QTDE MÍN. 10 PÇS



1.50



9046 CENTURY. MOD.: SUPER  
COLOR



3.86 9083 COSAT/DAGON/SELETRON.  
MOD.: JSR-2050N

REF.: JSR-2050N  
QTDE MÍN. 10 PÇS



5.20 9978 SATELITE. MOD.: ELSYS  
CROMUS



5.20 9914 ELSYS DUOMAX



SRE3000B



SRE3000C PLUS  
VECTOR 2004  
QTDE MÍN. 10 PÇS



8239 FRESAT. MOD.: 308R 3.72 8241 FRESAT. MOD.: 309R 1.00 8879 HICOM. MOD.: 358R 3.84



RXC1/ RXC3/ RXC5  
QTDE MÍN. 10 PÇS



8881 NOSTEC. MOD.: 346RC 1.00



9994 ORBISAT. MOD.: SST2100 5.50



9938 ORBISAT. MOD.: SS2200 4.32



9976 ORBISAT. MOD.: 2200 PLUS 5.50

PARA  
RECEPTORES  
ANALÓGICOS E  
DIGITAIS DA  
ORBISAT



8681 AMPLIM/PLASMATIC. MOD.: 328R 3.72

RP-600



7439 TECSAT. MOD.: 303R 1.00

3200 E10 MODELO  
ANTIGO  
QTDE MÍN. 10 PÇS



7736 TECSAT. MOD.: 301R 3.72

TC3000/ T3100  
PREMIUM



9137 VISION SAT. MOD.: 3000 3.72

\*SERVE PARA  
RECEPTORES  
ELSYS  
VSR2800 / 2900 /  
3000



9972 VISIONTEC. MOD: SLIM 4.60

V700/ 1000/ 2000  
SLIM

### C. REMOTOS LCD/PLASMA



8758 VISIONTEC. MOD.: VT1000P 3.72

FALCOM/  
AUDIONAK/  
VISIONTEC/  
NTCOM/ NEWTEC  
VT200/ VT300/  
VT1000/VTM100  
VERSÃO PRETA



8757 VISIONTEC. MOD.: VT1000C 3.72

FALCOM/  
AUDIONAK/  
VISIONTEC/  
NTCOM/ NEWTEC  
VT200/ VT300/  
VT1000/VTM100  
VERSÃO CINZA



7625 SUPEX. MOD.: SUPEX 1.00

SUBSTITUI  
CENTURY  
USR-1700/  
CALIFORNIA/  
VOLNIX/ RIGARI  
ETC.  
QTDE MÍN. 10 PÇS.



9984 AOC TV/ MONITOR LCD 5.80

COMPATÍVEL  
COM OS  
MODELOS:  
D32W831  
D42H831



CONTROLE REMOTOS - LCD/ PLASMA



9986 AOC. MOD.: LE42H057D

9.60

9965 CCE. MOD. RC512 STILE  
L2401D3201

11.00

9963 H BUSTER BRANCO

7.30

9962 H BUSTER. MOD.: HTR-D19

7.20

COMPATÍVEL  
COM OS  
MODELOS:  
**RC-512**  
CW3201 / D3201 /  
D32LED / D37 /  
D46 /  
L2401 / LW2401 /  
STILE D4201  
TVS LED E LCD

COMPATÍVEL  
COM OS  
MODELOS:  
**HTR-D17**  
HBTV 3203HD/  
HBTV 4203FD

COMPATÍVEL  
COM OS  
MODELOS:  
**HTR-D19**  
HBTV-32D01HD /  
HBTV-42D01HD /  
HBTV-32D02FD /  
HBTV-40D02FD /  
HBTV-32D03HD /  
HBTV-42D03HD



9950 LG. MOD.: MKJ32022840

9.00

9951 LG. MOD.: 6710900010S

10.88

9955 LG. MOD.: MKJ40653805

9.60

9952 LG. MOD.: MKJ32022805

11.30

COMPATÍVEL  
COM OS MODELOS:  
**MKJ32022840**  
LCD: 26LC4R / 26LC4RA  
/ 32LC4R / 37LC4R /  
42LC4R  
PLASMA: 42PC5R /  
42PC5RV / 42PC5RVH /  
50PC5R / 42PC7RA /  
42PC7RAH

COMPATÍVEL  
COM OS MODELOS:  
**6710900010S**  
42PBZRR / 50PA2RR  
UTILIZADO EM TV'S  
DE LCD E PLASMA  
42" E 50"

COMPATÍVEL  
COM OS MODELOS:  
**MKJ32022805**  
26LC2R /  
6710900010P /  
6710900010W /  
AKB69680401 /  
AKB69680406 /  
AKB69680409 / ETC



9953 LG. MOD.: MKJ42519602

8.42

9954 LG. MOD.: MKJ33981409

5.62

9955 LG. MOD.: AKB72915214

12.80

9956 LG. MOD.: AKB69680416

8.50

COMPATÍVEL  
COM OS MODELOS:  
**MKJ42519602**  
26LG30R / 32LG30R  
/ 37LG30R /  
42LG30R / 47LG30R  
/ 42PG30R /  
50PG30R

COMPATÍVEL  
COM OS  
MODELOS:  
**MKJ33981409**  
MKJ6161306

COMPATÍVEL  
COM OS MODELOS:  
**AKB72915214**  
TVs LCD: 32LD350 /  
32LD420 / 32LD460 /  
37LD460 / 42LD420 /  
42LD460 / 47LD460  
TVs LED: 22LE5300 /  
22LE6500 / 26LE5300 /  
26LE6500 / 32LE4300 /  
32LE4600 / 32LE5300 /  
37LE5300 / 42LE4300 /  
42LE4600 / 42LE5300 /  
47LE4600 / 47LE5300  
/ 55LE4600 / 55LE5300  
TVs PLASMA: 42PJ230 /  
50PJ230 / 42PJ250 /  
50PJ250 / 42PJ350 /  
50PJ350

COMPATÍVEL  
COM OS MODELOS:  
**AKB69680416**  
PARA TVS LCD:  
22LU50FR /  
26LU50FR /  
32LF20FR /  
42LF20FR /  
32LH30FR /  
42LH30FR / ETC



9957 LG. MOD.: MKJ42613813

12.00

9958 LG. MOD.: AKB72914245

9.70

9959 LG. MOD.: AKB72914210-221

13.30

9960 LG. MOD.: AKB73275616

9.90

COMPATÍVEL  
COM OS  
MODELOS:  
PARA TVS LCD:  
**MKJ42613813**

COMPATÍVEL  
COM OS MODELOS:  
TV LCD: 32LD840 /  
37LD840 / 42LD840 /  
47LD840  
TV LED 3D:  
42LX6500 / 47LX6500  
/ 55LX6500  
TV PLASMA 3D:  
50PX950 / 60PX950

COMPATÍVEL  
COM OS MODELOS:  
TVs LCD: 32LD350 /  
32LD420 / 32LD460 /  
37LD460 / 42LD420 /  
42LD460 / 47LD460  
TVs LED: 22LE5300 /  
22LE6500 / 26LE5300 /  
26LE6500 / 32LE4300 /  
32LE4600 / 32LE5300 /  
37LE5300 / 42LE4300 /  
42LE4600 / 42LE5300 /  
47LE4600 / 47LE5300  
/ 55LE4600 / 55LE5300  
TVs PLASMA: 42PJ230  
/ 50PJ230 / 42PJ250 /  
50PJ250 / 42PJ350 /  
50PJ350

COMPATÍVEL  
COM OS MODELOS:  
**AKB73275616**  
LED/LCD/LED:  
32LV3700 /  
42LV3700 /  
47LV3700 /  
32LV5500 /  
42LV5500 /  
47LV5500 /  
55LV5500





COMPATÍVEL  
COM OS MODELOS:  
TH-42PV70LB  
TH-50PV70LB

9964 PANASONIC VIERA. MOD.: TH-42PV70LB 7.30



COMPATÍVEL  
COM OS MODELOS:  
LCD: PH24M / PH24MR

9971 PHILCO. MOD.: PH24M-PH24MR 6.30



9989 PHILCO. MOD.: LCD PH32DPH32M 7.50



COMPATÍVEL  
COM OS MODELOS:  
RC2023606/01  
LCD/ PLASMA:  
32PFL3322 /  
32PFL5332 /  
42PFL7342 /  
42PFL3322 /  
42PFL5332 /  
42PFL7342 / ETC

9939 PHILIPS. MOD.: RC2023606/01 4.98



COMPATÍVEL  
COM OS MODELOS:  
21PT8467 /  
21PT9457 /  
29PT9467 /  
RC2023605

9940 PHILIPS. MOD.: TELEVISION 6.80



COMPATÍVEL  
COM OS MODELOS:  
22PF5320  
26PF5321  
32PF5320  
32PF5312  
42PF7320  
42PF7321  
42PF7312

9941 PHILIPS. MOD.: RC1683702/01 7.22



9991 PHILIPS. MOD.: RC1683701/01 5.30



COMPATÍVEL  
COM OS MODELOS:  
32PFL3403 /  
32PFL5403 /  
42PFL5403

9942 PHILIPS. MOD.: 32PFL5403-42PFL5403 8.50



COMPATÍVEL  
COM OS MODELOS:  
42PFL7803D /  
52PFL7803D

9943 PHILIPS. MOD.: 42/52 42PFL7803D-52PFL7803D 11.50



COMPATÍVEL  
COM OS MODELOS:  
LCD: RC2143608

9944 PHILIPS. MOD.: RC2143608-01 6.90



COMPATÍVEL  
COM OS MODELOS:  
46PFL3600

9945 PHILIPS. MOD.: SERIE 3000 16.80



COMPATÍVEL  
COM OS MODELOS:  
LCD:  
BN59-00690A  
BN59-00868A /  
BN59-00869A /  
VÁRIOS MODELOS DE  
TVS

9930 SAMSUNG. MOD.: BN59-00690A 7.70



COMPATÍVEL  
COM OS MODELOS:  
BN59-00604A

9931 SAMSUNG. MOD.: BN59-00604A 13.24



COMPATÍVEL  
COM OS MODELOS:  
BN59-00556A  
BN59-00545A / LN-26R71B  
/ LN-32R71B / LN-40R71B /  
LN-46N71B / LN-32R51N /  
LN-40R51 / LN-S2338W /  
LN-S2338WX / LN-S2341W  
/ LN-S2341WX / LN-S2351W  
/ LN-S2351WX  
TV PLASMA: PL-42E71S  
FUNCIONA EM TODAS AS  
TVS DA SAMSUNG DA  
LINHA CL/PL/ LN

9932 SAMSUNG. MOD.: BN59-00556A 6.20



COMPATÍVEL  
COM OS MODELOS:  
AA59-00385B  
CL-21K40MQ /  
CL-29K40MQ /  
CL-29Z30MQ /  
CL-29M21MQ /  
ETC

9933 SAMSUNG. MOD.: AA59-00385B 6.75



COMPATÍVEL  
COM OS MODELOS:  
AA59-00385B  
CL-21K40MQ /  
CL-29K40MQ /  
CL-29Z30MQ /  
CL-29M21MQ /  
ETC

9934 SAMSUNG. MOD.: AH59-02144M 9.90



COMPATÍVEL  
COM OS  
MODELOS:  
BN59-01011A



COMPATÍVEL  
COM OS  
MODELOS:  
BN59-00869A  
2033M



COMPATÍVEL  
COM OS  
MODELOS:  
BN59-0120A



COMPATÍVEL  
COM OS MODELOS:  
LCD SHARP  
AQUOS  
LC-32R24B

9935 SAMSUNG. MOD.: BN59-01011A 11.50

9936 SAMSUNG. MOD.: BN59-00869A 8.20

9937 SAMSUNG. MOD.: BN59-0120A 10.88

9968 SHARP. MOD.: AQUOS  
LC32R24B 10.90



COMPATÍVEL  
COM OS  
MODELOS:  
CT-90333  
LCD:  
LC 3247FDA /  
LC 4247FDA /  
32CV650DA /  
32XV600DA /  
42XV600DA



COMPATÍVEL  
COM OS MODELOS:  
CT6340  
LC1945W /  
LC2245W /  
LC2645W /  
LC3245W /  
LC4245W



COMPATÍVEL  
COM OS  
MODELOS:  
RM-YD023



COMPATÍVEL COM  
OS SEGUINTE  
MODELOS:  
BN59-00490A P/ TV  
PLASMA  
MOD PL-42D5S/  
42S5S/ 50P5H

9969 SEMP TOSHIBA. MOD.:  
CT90333 11.50

9970 SEMP TOSHIBA. MOD.: CT6340-  
LC3245W-LC42 7.00

9946 SONY. MOD.: RM-YD023 9.72

9992 SAMSUNG 5.50

**C. REMOTOS - TELEVISORES**



COMPATÍVEL  
COM OS MODELOS:  
RM-ED007  
KDF-50E2000 / KDF-50E2010  
/ KDL-15G2000 / KDL-  
20G2000 / KDL-20S2000 /  
KDL-20S2020 / KDL-20S2030  
/ KDL-20S4000 / KDL-  
20S4020 / KDL-26P2520 /  
KDL-26P2530 / KDL-26U2000  
/ KDL-32P2520 / KDL-  
32P2530 / KDL-32U2000 /  
KDL-32U2520 / KDL-32U2530  
/ KDL-40P2530 / KDL-  
40U2000 / KDL-40U2520 /  
KDL-40U2530 / ETC S



COMPATÍVEL  
COM OS  
MODELOS:  
RM-YA006  
KLV-40S200A /  
KLV-46S200A /  
KLV-S200AT /  
ETC  
SONY BRAVIA



COMPATÍVEL  
COM OS MODELOS:  
RM-YD047  
KDL-32BX305 / KDL-32EX305 /  
KDL-32EX306 / KDL-32EX405 /  
KDL-32EX605 / KDL-32EX607 /  
KDL-32EX705 / KDL-32EX707 /  
KDL-32EX715 / KDL-32EX717 /  
KDL-40BX405 / KDL-40EX405 /  
KDL-40EX406 / KDL-40EX505 /  
KDL-40EX605 / KDL-40EX607 /  
KDL-40EX705 / KDL-40EX707 /  
KDL-40EX715 / KDL-40EX717 /  
KDL-46EX405 / KDL-46EX505 /  
KDL-46EX605 / KDL-46EX607 /  
KDL-46EX705 / KDL-46EX707 /  
KDL-46EX715 / KDL-46EX717 /  
KDL-52EX705 / KDL-52EX707 /  
KDL-55EX505 / KDL-55EX717 /  
KDL-60EX505 / KDL-60EX705



AR145/ AR205/ RC  
ZVT06  
QTDE MIN. 10 PÇ;



9947 SONY. MOD.: RM-ED007 7.00

9948 SONY. MOD.: RM-YA006 6.50

9949 SONY. MOD.: RM-YD047 10.60

7714 AIWA. MOD.: 063A 1.50



PARA TVS E  
MONITORES



RC99/CTV 45631CC/  
5463ULCTT/ 4545LSTC/  
5454LTC "VERSÃO C/  
CRISTAL 480".



EM ESPECIAL P/ AS TV'S  
C/AS FUNÇÕES ST/SAP  
E CLOSED CAPITON.  
HPS 14R/ 1470/ 1480/  
1481/ 1490/ 2070/ 2080/  
2081/ 2090/ 2780/ 2781/  
2980/ 2981/ ETC.



HPS 1401/ 1492/ 2001/  
2092/ ETC.

9916 AOC. MOD.: M19W531 5.80

9228 BROKSONIC. MOD.: 018AII 4.02

7989 CCE HPS14R. MOD.: 0214B 4.42

7389 CCE HPS1401. MOD.:027A 3.40



HPS 1402/  
1404/ 2002/  
2004/ ETC.



HPS 1470/ 1480/  
1481/ 1490/ 2070/  
2080/ 2081/ 2780/  
2781/ 2980/ 2981/  
2D81.



CCE/PAXAN. CCE:HPS  
1491/ 1495/ 2091/ 2095  
PAXAN: 2027FS/ 21D49B/  
14AV49B/ 2095



CCE/CINERAL/ PAXAN  
CCE: HPS 1491/ 1495/  
2091/ 2095.  
CINERAL: 1422/ 2022.  
PAXAN: 14AV49/  
2027/ 21D49.

8582 CCE HPS1402. MOD.: 1402

4.46

7387 CCE HPS1470. MOD.: 026A

4.02

7797 CCE HPS1491. MOD.: 020A

3.00

7716 CCE HPS1491. MOD.: 035A

5.34



9981 CCE/ PHILIPS. MOD.: 214B

4.50



9966 CCE. MOD.: RC201

4.98



9967 CCE. MOD.: RC210

4.50



9921 CINERAL. MOD.: MAXI PLUS

5.40

COMPATÍVEL  
COM OS MODELOS:  
**RC-201**  
RC-206 / HPS1403 /  
HPS1405 / HPS2003 /  
HPS2004 / HPS2005 /  
HPS2006 / HPS2023 /  
HPS2706 / HPS2901 /  
HPS2904 / HPS2906 /  
HPS2912 / 29EBB199

COMPATÍVEL  
COM OS MODELOS:  
**RC210**  
HPS 2971/HPS 2171  
HPS 2991/HPS 2985  
HPS 2997/ HPS 2988  
HPS 3407/HPS 3477



QTDE MÍN. 10 PÇS

8882 CINERAL. MOD.: 2070

1.00



GRADIENTE/JVC.  
GRADIENTE: HRM33PS/  
290PS/ 370PS/ HTM388S  
/ 3343/ GT2825. JVC:  
RM44/ C729/ 1440/  
2040/ RMC672/ 722.

7720 GRADIENTE/JVC. MOD.: 074A

4.46



7399 GRADIENTE. MOD.: 029A

4.02



9047 GRADIENTE. MOD.:G-29FM

5.18



GT1411/ 1415/ 2011/  
2015.  
QTDE MÍN.: 10 PÇS

8469 GRADIENTE GT1411 002A

1.00



7718 GRADIENTE. MOD.:021A

3.84



8175 GRUNDING.MOD.: TP-720A

1.00



8177 KIREY. MOD.: 041A

3.84



14"/20"/29" -  
KTV1414/ 1430/ 2020/  
2929 C/FUNÇÕES  
TV-AV E AINDA  
P/TV'S CROWN/  
AIKO/ KTV/ FIRST-  
LINE/ PACIFIC/ SKE/  
CINERAL 14" E 20/  
ETC.





LG/ CCE/  
GRADIENTE. LG:  
CP14B85/ 14B86/  
14J52/ 14K40/ 14K85/  
15Q90/ 20B85/ 20J50/  
20J52/ 20K40/ 20K70/  
20K78/ 29C85/  
29K30. CCE: HPS14/  
HPS20/ HPS2990.  
GRADIENTE:  
GT1422/ 1425/ 1433/  
203/ 2022/ 2025.



REFS: 29FA30/ 29FA35/  
29K30 E TODA LINHA DE  
TV'S MAIS RECENTES  
DE 29" E PLASMA.



TVS: RP14CB20A/  
RP20CB20A/ ETC.



COMPATÍVEL  
COM OS MODELOS:  
**6710V00090H**  
RP-29CC25 / RP-29CC2RL /  
CP-14K40 / CP-14K85 / CP-  
20K40 / CP-29K30A / CP-  
29K35A / CP-29Q54A / RP-  
14CB25A / RP-21FB32 / RP-  
21FD10 / RP-21FD15 / RP-  
29FS4RL / ETC.  
SUBSTITUI OS CONTROLES  
REMOTOS: 6710V00090N /  
6710V00088Q / 6710V00076B

7993 LG. MOD.: 6710B00008K

4.74 9229 LG. MOD.: 6710V00088G

5.34 9155 LG. MOD.: 6710V00124E

5.04 9961 LG. MOD.: 6710V00090H 3.86



COMPATÍVEL  
COM OS  
MODELOS:  
TC1410 / 2010 /  
2910 - TC2004ST...



29FS/ TC2051/ 2054/  
2091/ 2094.  
QTDE MIN.: 10 PÇS



C/PIP  
"COMPLETO"  
P/TV'S C/ TC REF:  
1409/ 1418/ 2009/  
2118/ 2918PS/  
2990/ ETC.

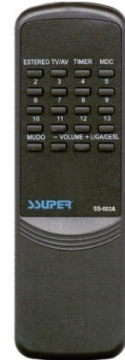

TC1441/ 1631/  
2031/ 2034/ 2041.  
QTDE MIN.: 10  
PÇS

9980 MITSUBISHI/ AIKO

4.76 7722 MITSUBISHI. MOD.:054A

1.00 7995 MITSUBISHI.MOD.: 053A

3.84 7403 MITSUBISHI. MOD.:003A 1.00



TC1492/ 1498/  
1499/ 2098/ 2099/  
2198.



PANASONIC. MOD.: 14-  
20RM10L



EUR501310/  
TC1416/ 2016/  
2140/ 2907/ 3408/  
TC14A4/ 20A4/  
29A8.



EUR501380/  
842M/ TC14A10/  
14C5/ 14C6/ 14C7/  
14C8/ 14C9/  
20A10/ 20C5/  
20C6/ 20C7/ 20C8/  
20C9.

7405 MITSUBISHI. MOD.:004

5.40 9998 PANASONIC. MOD.: 14-  
20RM10L 4.96

7409 PANASONIC. MOD.: 005A

4.02 7411 PANASONIC. MOD.: 064A 3.92



EUR7717060/  
TC14RM10/  
14RM12/ 14RM15/  
20RM10/ 20RM12/  
20RM15/ 29KL03/  
29KL04/ 29KL05/  
ETC.



14A12/ 14KL03/  
14KL03/TC14A04/  
20A12/ 20KL03/  
20KL04/ TC20A04/  
ETC.



TC14C1 / 14C2 /  
20C1/ 20C2.  
QTDE MIN.: 10 PÇS.



29V50  
QTDE MIN.: 10 PÇS.

9224 PANASONIC. MOD.:  
EUR7717060

4.24 8768 PANASONIC. MOD.:20A12

4.64 7726 PANASONIC. MOD.: 073A

1.00 7413 PANASONIC. MOD.: 070A 1.00





PC20R36/ 20R38/  
20R42/ 2136/ 2142/  
1436/ 1438/ 1444/  
1446/ 2036/ 2038/  
2044/ 2046/  
PAVM2160/ 2162/  
2900/ 2901/ 2920P/  
PCS2700/ 2950/  
2952/ TP1452NIS/  
1453NIS/ 2052NIS/  
2062NIS/ 2063N/  
2064N/ PCS2976/  
ETC.

8596 PHILCO. MOD.: PCR97F 5.18



PC1426/ 2026U/  
1428/ 2028U/ ETC.  
QTDE MÍN. 10  
PÇS.



8590 PHILCO. MOD.: PCR1 1.00



PC1436/ 1438/  
1444/ 1446/ 1449/  
1451/ 2036/ 2038/  
2044/ 2046/ 2162/  
PAVM2160/ 2162/  
2900/ 2901/ 2920P/  
PCS2700/ 2950/  
2952/ ETC.

7997 PHILCO. MOD.: PCR44 3.72



PC20R36/ 20R38/  
20R42/ 2136/ 2142/  
ETC.  
QTDE MÍN. 10  
PÇS.



8251 PHILCO. MOD.: PCR31 1.00



PCR27  
QTDE MÍN. 10 PÇS

7415 PHILCO. MOD.: PCR27 1.00



PARA TV E VK7.  
QTDE MÍN. 10 PÇS



4838 PHILCO. MOD.: PCR28 1.00



TP1452N/S/  
1453N/S/ 2052N/S/  
2053N/S/ 2062N/S/  
2063N/ 2064N/  
PCS2976/ ETC.  
VERSÃO COR  
PRETA.

8255 PHILCO. MOD.: PCR70 4.12



VT1410/ 1412/ 1414/  
2010/ 2012/ 2014.  
QTDE MÍN. 10 PÇS



8592 PHILCO. MOD.: PCR32/PCR55 1.00



P/TV'S E VK7  
PVT1416/ 1418/  
2016/ 2018/ 2028/  
PVTS2020.  
QTDE MÍN. 10 PÇS



8594 PHILCO. MOD.: PCR90 1.00



TP1452N/S/  
1453N/S/ 2052N/S/  
2053N/S/ 2062N/S/  
2063N/ 2064N/  
PCS2976/ ETC.  
VERSÃO COR  
CINZA.

3.84

8257 PHILCO. MOD.: PCR93



P/TV'S E VK7.  
QTDE MÍN. 10 PÇS



8475 PHILCO. MOD.: PCR91 1.00



PHILCO. MOD.: PH21U5/9H29U5

9977 A2 6.60



9990 PHILCO 6.60



P/TV'S  
C/FUNÇÕES  
BÁSICAS P/DVD  
14PT218/  
14PT519/  
20PT529/  
21PT639/  
21PT739/  
29PT458/  
29PT558/  
29PT658/ ETC.

4.44

8259 PHILIPS. MOD.: 86563



20PT524A/ 21PT534A/  
21PT836A/ 21PT838/  
25PT848/ 29PT458A/  
29PT552A/ 29PT554/  
29PT558A/ 29PT658A/  
33PT574A/ 33PT578A/  
33PT630/ 33PT785/  
33PT856.

7421 PHILIPS. MOD.: 28350 4.26



LINHA ANUBIS/  
21GX1665/  
21XG2166/  
20GX1855/  
20GX1888/ ETC.

8481 PHILIPS. MOD.: 045A 4.54



SMART 14PT110/  
14PT120/  
20PT120A/  
20PT121A/  
21PT212/  
21PT222/  
21PT230/  
29PT552A/ ETC.



28CT7690/ 7692/ 7693/  
7694/ ETC... C/A  
FUNÇÃO PIP E  
28CT7470/ 7678 S / A  
FUNÇÃO PIP.  
QTDE. MÍN. 10 PÇS.



P/TODA LINHA  
CTO E GR  
MONO/STEREO  
\*COMPLETO  
C/TODAS  
FUNÇÕES.  
QTDE. MÍN. 10  
PÇS.



P/DIVERSAS TV'S  
DE 14" E 20" E P/  
ALGUNS MOD.DE  
TV'S DESTA NOVA  
GERAÇÃO DE TV'S  
ATUAIS.  
QTDE. MÍN. 10  
PÇS.



PRODUTO ORIGINAL

PRODUTO ORIGINAL

7417 PHILIPS. MOD.: 058A

4.54

7730 PHILIPS. MOD.: 057A

1.00

6817 PHILIPS. MOD.:CTO/GR

1.00

5642 SAMSUNG 14/20

1.00



CTP2996/ 2997/  
29LH43/ 3792/  
6792/ ETC.



CTP2796/ 2996/ 3791/  
3792/ 3796/ 6790/ 6791/  
6792/ 6796/ 6797/  
29LB/ 29LB1/  
AVM1440/ 2040.  
QTDE. MÍN. 10 PÇS.



VM1440/ CTP3791/  
3792/ 3796/  
VM2040/ CTP6791/  
6792/ 6796/ 6797/  
CTPC2796/  
CTP2996.



COMPATÍVEL  
COM OS MODELOS:  
CT3600/ 3700/ 4300/  
4400/ 4500/ 4800/  
4900/ 5000/ 5300/  
5400/ 5600/ 5700/  
5800/ 6200/ 6210/  
6220/ 6300/ 6400/  
6500/ 7000/ 7010/  
7020/ 7030/ 7040/  
7050/ 7060/ 7080/  
7100/ ETC.  
SUBST AS REF.  
CT3400/ CT3500  
"MENOS A FUNÇÃO  
PIP"  
MOD. CT-9430  
QTDE MÍN: 10 PÇS



8263 SANYO. MOD.: FXMR

3.45

7732 SANYO. MOD.: 008A

1.00

6700 SANYO. MOD.: FXZA

3.00

7300 SEMP TOSHIBA. MOD.:CT-9430

1.00



COMPATÍVEL  
COM OS MODELOS:  
CT4300/ 4400/ 4500/  
4900/ 5000/ 5300/  
5400/ 5600/ 5700/  
5800/ 6200/ 6210/  
6220/ ETC.  
TV1022AV/ 1022CAV/  
1022DAV/ 1022E/  
1022EAV/ 1022FAV/  
1022HAV/ 10A22EAV/  
1449M/ 1455M/ ETC.  
VERSÃO GABINETE  
E MANTA PRETA  
MOD. 046AP



CT1020/ 1460/ 1470/  
1480/ 2060/ 2070/ 2080/  
CT4900.  
QTDE MÍN: 10 PÇS



CT5300/ 5700/ 5900/  
6230/ 6900/ 7010/  
7020/ 7030/ 7040/  
7050/ 7060/ 7070/  
7080, COM FUNÇÃO  
CLOSED CAPTION.  
QTDE MÍN: 10 PÇS



PARA TODA  
LINHA LUMINA.



8780 SEMP TOSHIBA. MOD.:046A

4.00

7429 SEMP TOSHIBA. MOD.:CT4900  
009A

1.00

7433 SEMP TOSHIBA. MOD.:CT5300  
042A

1.00

8491 SEMP TOSHIBA. MOD.:LUMINA  
CT7180

3.86



C/A FUNÇÃO PIP E  
FUNÇÕES COMPLETAS  
PVK7 DA MESMA  
MARCA.  
QTDE MÍN: 10 PÇS



COMPATÍVEL COM  
OS MODELOS:  
C 14R-12  
C 14R-52  
C 20R-12  
C 14RS02  
C 20RS02  
C 14T-51  
C 20T-51



C1438/ C2038/ ETC



C1413/ 1438/ 1457/  
14ST57/ 2013/ 2038/  
2057/ 20ST57/ ETC.

8003 SEMP TOSHIBA. MOD.:TZ  
61A/60A 8010

1.00

9922 SHARP. MOD.: C0851

4.90

8007 SHARP. MOD.: 000160

4.42

8265 SHARP. MOD.: BANANA

5.54



CT9430, SUBST. AS  
REF. CT3400/  
CT3500 "MENOS A  
FUNÇÃO PIP".  
QTDE MÍN. 10 PÇS.



ÚLTIMA GERAÇÃO  
TV'S VENDIDAS  
DESTA MARCA NO  
BRASIL C/FUNÇÕES  
PIP/FREEZE.  
QTDE MÍN. 10 PÇS.



14", 21", 27" E 29"  
TRINITRON.

7799 SHARP. MOD.: 011A

1.00

8181 SHARP. MOD.: PIP/FREEZE

1.00

9987 SONY. MOD.: RM-YA008

8.90

7302 SONY. MOD.: RM-Y116

4.24

**C. REMOTOS - TVS ASSINATURA**



TRINITRON, TODOS  
MODELOS QUE  
LEVEM A FUNÇÃO  
SURROUND.



LINHA WEGA/  
TRINITRON, COR:  
PRETA.  
QTDE MÍN.: 10 PÇS



SAR1453/ 2053/  
2153/ 2953/ ETC... E  
P/OUTRAS TV'S DE  
DIVERSA MARCAS,  
ACOMPANHA "BULA"  
P/ CODIFICAÇÕES,  
TANTO P/TV'S,  
VK7'S, ETC.



7427 SONY. MOD.: RM-861

4.42

8499 SONY. MOD.: RM-Y171

1.00

7603 ZENITH. MOD.: 3445

10.62

9988 EMBRATEL

6.50



QTDE MÍN.: 10 PÇS

**PRODUTO ORIGINAL**



GSD100/06A/  
GSD100/7A/ GSD400.  
QTDE MÍN.: 10 PÇS



GSD-1500 E  
MOTOROLA.  
QTDE MÍN.: 10 PÇS



9979 SKY. MOD.: 1640/00

7.80

9511 GRADIENTE SKY GSD 1000

1.00

7401 GRADIENTE GSD400 040A

4.30

8762 GRADIENTE/SKY GSD 1500

8.00



QTDE MÍN.: 10 PÇS



NET DA REGIÃO  
SUDESTE (SÃO  
PAULO, RIO DE  
JANEIRO E MINAS  
GERAIS)  
QTDE MÍN.: 10 PÇS



8763 GRADIENTE/SKY MOTOROLA

1.00

9973 NET DIGITAL BLACK

6.00

8767 NET. MOD.: ESD

1.00

9140 NET DIGITAL. MOD.: RCZ-111-SJ1G

5.04



CONTROLES REMOTOS - UNIVERSAL/ VK7



8598 PHILIPS/SKY. MOD.: SSKY-II 5.04



COMPATÍVEL C/ AS  
MARCAS:  
DAEWOO, NEC,  
AIWA/TLC, SKYWORTH,  
HAIER, SANYO  
PANASONIC, HITASHI,  
PHILIPS/SHARP,  
SONY , TOSHIBA, LG/  
SAMSUNG, ETC.

9920 TV UNIVERSAL 7.72



COMPATÍVEL C/ AS  
MARCAS:  
DAEWOO, NEC,  
AIWA/TLC, SKYWORTH,  
HAIER, SANYO  
PANASONIC, HITASHI,  
PHILIPS/SHARP,  
SONY , TOSHIBA, LG/  
SAMSUNG, ETC.

9982 UNIVERSAL TV 7.72



P/ MAIS DE 100  
MARCAS DE TV'S E  
CATV SAT ATRAVÉS  
DE CODIFICAÇÃO E  
USO DIRETO P/ 1ª  
VERSÃO DA DIRECT  
TV E TV'S GE E RCA.  
QTDE MÍN.: 10 PÇS

7443 UNIVERSAL. MOD.: RCA 1.00



VK7.  
QTDE MÍN.: 10 PÇS

9512 CCE VCR90X 1.00



GV202/ GV404/  
GV407/GV409/  
GV410/ GV 850/  
GV860/ GV870/ ETC  
QTDE MÍN.: 10 PÇS

PRODUTO ORIGINAL

7486 GRADIENTE GV202 1.00



GV202/ GV404/  
GV407/GV409/  
GV410/ GV 850/  
GV860/ GV870/ ETC  
QTDE MÍN.: 10 PÇS

7991 GRADIENTE GV202 400VC 1.00



GV202/ GV404/  
GV407/GV409/ GV410  
QTDE MÍN.: 10 PÇS

PRODUTO ORIGINAL

8761 GRADIENTE GV202 1.00



QTDE MÍN.: 10 PÇS

PRODUTO ORIGINAL

9513 GRADIENTE FACIT/SYNFONIC 1.00



PARA TODA LINHA  
VK7 DESTA MARCA  
QTDE MÍN.: 10 PÇS

8243 JVC. MOD.: 600VC 1.00



QTDE MÍN.: 10 PÇS

PRODUTO ORIGINAL

8769 PHILCO. MOD.:PCR37 1.00



VCR355/ 453/  
454/456/756/ ETC  
QTDE MÍN.: 10 PÇS

8179 PHILIPS. MOD.: 500VC 1.00



PARA TODA LINHA  
VK7 DESTA MARCA  
QTDE MÍN.: 10 PÇS



8261 PHILIPS. MOD.:355VC 1.00



COM FUNÇÕES  
BÁSICAS P/ TV'S DA  
MESMA MARCA.  
REF: VC622/ 766/  
767/ 768/ ETC.  
QTDE MÍN.: 10 PÇS



8005 SEMP TOSHIBA. MOD.:VC622 1.00



CÓD.	MODELO	MED	C.F	C.A	Ø	PREÇO
5495	101022 TR600 AM/FM	220	227	865	6,5	1.00
5496	101048 RT-85905 R.GRAVADOR	305	340	905	6,5	1.00
4990	101178 RDF-M42 AM/FM	175	200	795	6,0	1.00
5502	101261 RP35 AM/FM	130	155	790	7,4	1.00
5504	101394 RL302/AL381 R.GRAV.	178	209	820	7,0	1.00
4993	101402 GF-1602 X AM/FM	174	201	925	6,5	1.00
4995	101428 GF 2500B	151	286	965	6,5	1.00
4996	101436 GF-6060	303	340	900	6,0	1.00
4999	101485 QT-12Z AM/FM	191	227	900	6,0	1.00
5000	101493 CR210 AM/FM	146	159	725	8,0	1.00
5506	101501 CR259 AM/FM	175	187	910	8,0	1.00
5001	101519 CR-281 AM/FM	200	215	978	8,0	1.00
5002	101527 CR-440/610 AM/FM	222	250	868	6,5	1.00
5007	101576 CR-340/380 AM/FM	195	217	725	5,6	1.00
5008	101592 RX-1454M AM/FM	227	252	860	6,5	1.00
5009	101600 M2420-F/M2429-2F	220	252	865	6,5	1.00
5508	101618 M9902/9923/2402-2F	225	250	845	5,6	1.00
5010	101626 M-2800F AM/FM	213	237	705	5,6	1.00
5509	101642 8500F AM/FM	215	238	705	5,6	1.00
5015	101691 M-9800K AM/FM	224	249	705	5,6	1.00
5018	101766 CS-855D/CS-965	295	318	755	5,6	1.00
5019	101774 CS-825	230	247	630	5,6	1.00
5512	101806 CD214 R.GRAVADOR	300	335	850	6,0	1.00
5022	101838 AR-4 30-450	280	244	830	6,0	1.00
5023	102020 B253 TV	176	181	895	7,0	1.00
5024	102038 TV B251	262	265	943	7,0	1.00
5026	102053 312-140/444-170/PB 14"	143	172	870	7,4	1.00
5029	102111TX-12" TV	281	287	1000	7,0	1.00
5513	102152 TV MITS-14", 16" E 20"	271	295	1035	6,5	1.00

# R\$1,00 \*

\*Quantidade mínima: 20 peças por modelo

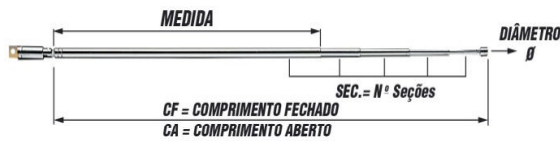

## ANTENAS



1161 ANTENA TV BROKSONIC 4 EST. BASE GIRATÓRIA 3.50



1162 ANTENA TV BROKSONIC 5 EST. BASE GIRATÓRIA 3.50



1163 ANTENA TV IMPORT. 4 EST. 4.10



1164 ANTENA INTERNA AMPLIFICADA 61.00

## ALTO-FALANTES



ACIMA DE  
100 PÇS  
**R\$1.00**  
(UNIDADE)

1095 2" X 3" 1/2 8Ω C/SUSP S/FIX BLINDADO 1.50



3427 A.FALANTE 2 1/4 X 5 8R C/SUSP 6.50



1979 4" 8Ω ALNICO 1.00



6138 3" 8Ω C/SUSP BLINDADO 3.00



8421 4" 4Ω C/SUSP BLINDADO 7.00



7362 4" 8Ω C/SUSP BLINDADO 7.00



3077 4" 8Ω C/SUSP BLINDADO 6.00



5291 5" 8Ω C/SUSP 25W BLINDADO 3.00



8723 3" 8Ω C/SUSP BLINDADO 7.00



6723 4" 4Ω S/SUSP 5W FERRITE 1.50



2238 4" 8Ω S/SUSP 5W FERRITE 1.50



5292 5" 4Ω C/SUSP 20W 4.00



3777 5" 4Ω S/SUSP FERRITE 1.50



8866 5" 6Ω C/SUSP 15W FERRITE 7.60



8366 5" 8Ω C/SUSP 25W IMÃ DUPLO FERRITE 9.30



8867 5" 8Ω C/SUSP 15W FERRITE 5.00



8868 5" 8Ω C/SUSP 20W FERRITE 7.50



8869 5" 1/2 6Ω C/SUSP CONE BR FERRITE 6.00



8871 5" 1/2 6Ω C/SUSP CONE POLIPR. FERRITE 6.00



8870 5" 1/2 8Ω C/SUSP CONE BR FERRITE 6.00



8664 FERRITE 2" 8Ω C/SUSP S/FIX 1.00



8865 2" 1/2 8Ω S/FIX FERRITE 0.90



2235 3" 15/16Ω S/FIX ALNICO 1.50



8862 4" 8Ω C/SUSP S/FIX ALNICO 1.00



6311 ALNICO 4" 8Ω S/SUSP S/FIX 1.00

## TWEETER



8540 TWEETER P/CAIXA DE SOM 8R 65MM 1.50



8541 TWEETER SISTEMA PIEZO 75W PT104 4.00



1218 TWEETER 106B 75/300W 4.00



1197 TWEETER 309B1 75/150W 4.00

## ADAPTADORES, PLUGUES E EMENDAS



1004 EMENDA RCA PLÁSTICO SIMPLES 0.45



1005 EMENDA RCA PLÁSTICO DUPLO 1.00













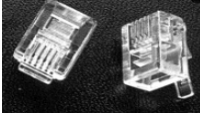



1169 EMENDA RCA FÊMEA TRIPLA 1.10



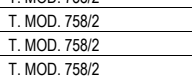

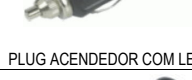



**ADAPTADORES /EMENDAS RJ**

	ADAPTADOR PINO EUROPEU PARA "F" COM ROSCA	1191	0.80
	PLUG PINO EUROPEU MACHO P/FÊMEA JR6235 (MIN.10PCS)	2315	0.80
	PLUG ADAP. F MACHO ENG.RAP.P/ F FÊMEA ROSCA (MIN.10PCS)	8613	0.85
	PLUG F MACHO P/RCA FÊMEA PT1396 (MIN.10PCS)	5154	0.60
	PLUG F P/CLIMPAR RF59 TIPO BARRIL (MIN.10PCS)	9243	1.00
	PLUG F ROSCA MET.C/ANEL "CORPO LONGO" (MIN.20PCS)	8033	0.16
	PLUG F ROSCA RG6 (MIN.20PCS)	3090	0.30
	PLUG "F" RG-6 COM ANEL (MÍN 20 UN.)	1108	0.35
	PLUG F ROSCA RG59 "PROFISSIONAL" 75R ENCAIXE DE ROSCA SOB PRESSÃO (MIN.20PCS)	3088	0.30
	PLUG F TIPO "BARRIL" RG-6	1189	1.00

	PLUG BNC MACHO P/CLIMPAR EM CABO 75R (MIN.10PCS)	9242	0.70
	PLUG BNC C/ MOLA E PARAFUSO	1089	2.00
	PLUG ADAP. BNC 75R P/F FÊMEA C/ROSCA JR6047 (MIN.10PCS)	2668	1.60
	PLUG ADAP. BNC 75R P/RCA FÊMEA NIQ.JR6041 (MIN.10PCS)	1636	0.88
	EMENDA BNC FÊMEA X FÊMEA	1225	0.90
	CONECTOR RG-6 COMPRESSÃO	7545	3.20
	CONECTOR RG-6 CP8404CY AMARELO	1060	1.80
	CONECTOR RG-6 CP8404BCQ AZUL	1059	1.80
	CONECTOR EMENDA F / RG58/50/RG59/75	3897	0.30
	CONECTOR F FÊMEA P/PAINEL	7540	0.60

**RG-6**

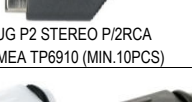
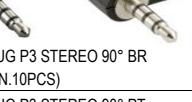
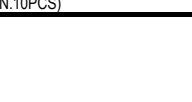
	PLUG MODULAR RJ11 (6X4) P/TELE.FAX (MIN.20PCS)	1382	0.14
	PLUG MODULAR RJ45 (8X8) CAT5 (MIN.20PCS)	7815	0.25
	CAPA P/PLUG MOD.RJ45 (8X8) CAT5 AZ (MIN.20PCS)	7813	0.12
	PLUG ACOP.TELEF.6X4 5 FÊMEAS X 1 MACHO RABICHO	9493	4.60
	ADAPTADOR 1 RJ-11 P/ 2 RJ-11	1184	1.40
	PLUG ADAP.EMENDA RJ11 CAT.5 6P4C MOD.KD1-6P4C	8509	0.55
	PLUG ADAP.EMENDA RJ45 CAT.5 8P8C MOD.KD1-8P8C	8510	1.50
	8506 BG T. MOD. 758/2	3.15	
	8506 BR T. MOD. 758/2	3.15	
	8506 CZ T. MOD. 758/2	3.15	
	8506 PT T. MOD. 758/2	3.15	
	PLUG ACENDEDOR COM LED	1217	1.70
	PLUG P/ LIGAR NO ACENDEDOR DE CIGARRO DO CARRO. MOD. WM-5171	7953	1.40
	PLUG ANTENA PHILIPS - (MÍN 10 PCS)	1372	0.40

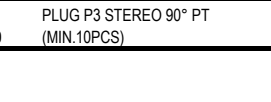
	PLUG ADAP.MACHO MINI DIN P/FÊMEA RCA MOD.JR2735-4P	8523	2.00
	PLUG (MACHO) P1 STEREO JACK (FÊMEA) J2 STEREO	9044	0.80
	PLUG P1 STEREO P/J2 STEREO IPOD (MIN.10PCS)	9102	0.50
	PLUG P1 STEREO 90° PT (MIN.10PCS)	9104	0.55
	PLUG P1 STEREO 90° BR (MIN.10PCS)	9100	0.55
	PLUG P1 STEREO 180° BK (MIN.10PCS)	9098	0.45
	PLUG P1 STEREO 180° PT (MIN.10PCS)	9098	0.45
	PLUG P2 MONO PT (MIN.10PCS)	8963	0.25
	PLUG P2 STEREO 180° PT (MIN.10PCS)	1384	0.40
	PLUG P2 METALICO STEREO	1099	0.90
	PLUG P2 MONO P/J4 FÊMEA 2,1MM JR1834C	8518	2.00
	PLUG P2 MONO P/J4 FÊMEA 2,5MM JR1834D	8519	2.00
	PLUG P2 STEREO P/2 J2 STEREO TP6902 (MIN.10PCS)	3420	0.60
	PLUG P2 STEREO P/2RCA FÊMEA TP6910 (MIN.10PCS)	6994	0.90
	PLUG P3 STEREO 90° BR (MIN.10PCS)	9112	0.90
	PLUG P3 STEREO 90° PT (MIN.10PCS)	9110	0.90



	1094	PLUG P4 COM BORNE DE ALIMENTACAO	2.40		8344	PLUG P4 WM5178 0,7X2,5X9,0MM (MIN.10PCS)	0.35		<b>RCA MACHO METALICO DOURADO</b>		<b>PLUG BANANA PLU1702A GROSSO ("QTDE MINIMA 10 PCS")</b>	9175 AZ AZUL	1.30		
	8522	PLUG P4 MACHO 1,0MM P/J4 FEMEIA 2,1MM JR1826C	2.00		8345	PLUG P4 WM5178G 3,1X6,3X14,0MM (MIN.10PCS)	0.45		<b>RCA MACHO METALICO NIQUEL</b>	<b>JACKS</b>					
	8514	PLUG P4 MACHO 1,3MM P/J4 FEMEIA 2,1MM JR1828C	2.00		1170	PLUG P10 COM TRAVA E MOLA ESPIRALADA	3.00		8347 PT PLU-1519B C/ MOLA	1.30		1577	JACK MONO ABERTO IMP. P/ PLUGAO	0.70	
	8515	PLUG P4 MACHO 1,3MM P/J4 FEMEIA 2,5MM JR1829D	2.00		1171	PLUG P10 COM MOLA ESPIRALADA	2.00		8347 VM PLU-1519B C/ MOLA	1.30		8196	JACK MONO FECHADO C/ROSCA E PORCA IMP.P/PLUG P10	0.40	
	8521	PLUG P4 MACHO 2,1MM P/J2 FEMEIA 3,5MM JR1836C	2.00		2584	PLUG MICROFONE MONO METAL C/MOLA (MIN.10PCS)	1.00		8350 PT PLU-1520A C/ MOLA	1.70		3407	JACK J8 MONO FECHADO EIXO PLAST.C/PORCA (MIN.10PCS)	0.30	
	8516	PLUG P4 MACHO 2,1MM P/J4 FEMEIA 2,5MM JR1831D	2.00		2585	PLUG MICROFONE STEREO METAL C/MOLA (MIN.10PCS)	1.00		8350 VM PLU-1520A C/ MOLA	1.70		8028	JACK J10 STEREO ABERTO EIXO MET.C/PORCA (MIN.10PCS)	0.45	
	8517	PLUG P4 MACHO 2,5MM P/J4 FEMEIA 2,1MM JR1833C	2.00		1576	PLUG CANNON FEMEIA PARA CABO IMPORTADO (MIN.10PCS)	2.00		4088	PLUG RCA MACHO P/2 RCA FEMEIA JR1920C (MIN.10PCS)	0.70		1578	JACK J10 STEREO ABERTO EIXO MET.C/PORCA (MIN.10PCS)	0.45
	8520	PLUG P4 MACHO 3,0MM P/J1 FEMEIA 2,5MM JR1835E	2.00		1705	PLUG CANNON MACHO P/ CABO IMPORTADO (MIN.10PCS)	2.00		1639	PLUG ADAP.PINO CHATO P/PINO REDONDO	0.65		8030	JACK J10 STEREO FECHADO EIXO MET.C/PORCA (MIN.10PCS)	0.50
	6391	PLUG P4 MINI MOD.349 1,4X3,4X9MM (MIN.10PCS)	0.22		1053	ADAPTADOR 2RCA FEMEIA X P10 STEREO	1.10		<b>PLUG BANANA JR0514 GROSSO BANHADO A OURO ("QTDE MINIMA: 10 PCS")</b>	6000 AM AMARELO	0.60		1974	JACK J10 STEREO FECHADO EIXO MET.C/PORCA (MIN.10PCS)	0.50
	8337	PLUG P4 MOD.10169 0,7X2,5MM PONTA PLAST.(MIN.10PCS)	0.35		1074	ADAPTADOR JACK RCA PARA P10 MONO	0.80		<b>PLUG BANANA MINI PB066 ("QTDE MINIMA 10 PCS")</b>	4087 PT PRETO	0.60		9097	JACK MINI DIN P/SUPER VHS P/SOLDA PCI FIX.PARAFUSO	0.30
	8341	PLUG P4 WM5065A 1,0X3,8X9,0MM (MIN.10PCS)	0.35		1076	ADAPTADOR JACK J10 MONO PARA P2 STEREO	0.70		<b>PLUG BANANA PB086 GROSSO ("QTDE MINIMA 10 PCS")</b>	6000 VL VIOLETA	0.60		7539	JACK MACHO IEC PAINEL C/FILTRO 3A 115/250V	3.00
					1185	PLUG ADAPTADOR J2 X P10 STEREO	0.70		<b>PLUG BANANA PB086 GROSSO ("QTDE MINIMA 10 PCS")</b>	4087 VM VERMELHO	0.60		3111	JACK FEMEIA P/PAINEL	2.00
									<b>PLUG BANANA PB086 GROSSO ("QTDE MINIMA 10 PCS")</b>	5999 AM AMARELO	1.30		3135	JACK MACHO P/PAINEL	1.60
										5999 AZ AZUL	1.30				
										5999 VD VERDE	1.30				



1178 JACK J2 MONO PARA PAINEL PJ301A 0.40



1009 JACK J4 P/ PLACA 2,1 X 5,5MM 0.24



1186 SPEAKON 4 VIAS MACHO AZ 4.20



1188 SPEAKON 4 VIAS FÊMEA AZ 2.00

**BORNES**



3964 BORNE SAÍDA DE FALANTES 0.30



1232 BORNE QUADRADO P/ CAIXA 1.00

**BATERIAS**



9173 BATERIA 12V GP 27A PARA CONTROLE (UNIDADE) 3.30



9133 BATERIA 9V COMUM (BLISTER COM 2 UNIDADES) 6.00



1145 BATERIA 9V COMUM GP 1604S CONSULTE



3517 CLIPS BATERIA 9V 0.29



7038 BATERIA RECAR.TEL.S/FIO AA 300MA 2.4V TC 104 C-1 12.00



7039 BATERIA RECAR.TEL.S/FIO AA 300MA 3.6V TC 107 C-1 12.00



9534 BATERIA RECAR.TEL.S/FIO AAA 600MA 2.4V 12.00



7040 BATERIA RECAR.TEL.S/FIO AA 600MA 3.6V T 110 C-1 12.00



9533 BATERIA RECAR.TEL.S/FIO AAA 650MA 3.6V 12.00



3992 BATERIA CR2016 BLISTER C/5 UNID. 7.00



1674 BATERIA CR2025 BLISTER C/5 UNID. 8.00



1673 BATERIA CR2032 BLISTER C/5 UNID. 8.00



2352 BATERIA ALCALINA A23/MN21 12V P/ CONTROLE 2.20



1084 PILHA PHILIPS AAA - CAIXA COM 48 UNIDADES 30.00



1083 PILHA PHILIPS AA - CAIXA COM 48 UNIDADES 30.00

9538 PILHA AA 1.5V - EMB. COM 4 UNIDADES 2.80



9537 PILHA AA 1.5V ALCALINA - BLISTER COM 2 UNIDADES 3.10



716 SUPORTE PARA PILHA PEQUENA C/2 0.80

**BALLON E CACHIMBOS**



1160 BALLON AEREO COM CAPA 1.30



1507 BALLON AÉREO VHF/UHF 75/300R 0.65



5336 CACHIMBO 300Ω (MIN.20PCS) 0.90



6324 CACHIMBO 75/300Ω (MIN.20PCS) 0.50



1181 CACHIMBO MILFRA 75/300Ω (MIN.10PCS) 1.25



3837 MISTURADOR VHF/UHF 75/300Ω C/ROSCA 2.50

1356 MISTURADOR VHF/UHF 75/300Ω S/ROSCA 2.00

**CABOS**



1100 CABO FIBRA OTICA 2 MTS COMUM 18.00



1233 CABO FIBRA OTICA 2 MTS UNIVERSAL 28.50



1097 CABO VGA X 3RCA -1.8MT 10.00

**\*\*SÓ FUNCIONA SE A PLACA DE VÍDEO OU NOTEBOOK TIVER "TV-OUT"**



1194 CABO SUPER VGA DB15 MACHO X DB15 FÊMEA 2MT COM FILTRO 14.00



1222 CABO DB15 MACHO X DB15 MACHO 1,50 MT AZUL C/ FILTRO 12.00



1203 CABO DE MICROFONE MONO 6,5MM 5MTS DOURADO 18.00



1096 CABO HDMI X HDMI MINI - 30AWG - 1MT 16.00



1144 CABO HDMI 1.0MT 18.00



1229 CABO HDMI 1.5MT 20.00

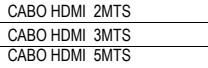

9539 CABO HDMI 2MTS 22.00

9540 CABO HDMI 3MTS 28.00

9541 CABO HDMI 5MTS 32.00

					
1032 CABO HDMI PARA DVI 18 PINOS 28AWG 2.0MT <u>20.00</u>		1088 CABO FORÇA FONTE NOTEBOOK 4.8MM 1.80M <u>12.00</u>		4881 2RCA MACHO + 1P2 STEREO 1,80MTS PT <u>2.30</u>	
1208 CABO HDMI PARA DVI 24 PINOS 28AWG 1,80MT <u>22.00</u>					
		1098 CABO DE FORÇA TRIPOLAR 1.5MT 90° <u>14.00</u>		2792 2RCA MACHO + 2RCA MACHO 1,80MTS INJ.B.OURO <u>1.00</u>	
					
7538 CABO USB "A" MACHO + USB "B" MACHO 1,80MTS <u>4.30</u>		1236 CABO TRIPOLAR 180° 90CM <u>5.00</u>		2641 2RCA MACHO + 2RCA MACHO 1,80MTS INJ.B.OURO <u>1.30</u>	
					
1235 CABO USB X USB MICRO P/ CELULAR 1.5MT <u>4.20</u>		9154 NOTEBOOK 1,80MTS PT <u>12.00</u>		1159 2RCA MACHO + 2RCA MACHO 2,00MTS PROF <u>6.00</u>	
					
1209 CABO USB "A" MACHO PARA USB "A" FÊMEA 1,80MT <u>4.80</u>		6704 BIP 2 X 20 X 1,50MTS PT PHILIPS (0,50MM) <u>4.00</u>		1054 CABO 3RCA +3RCA VIDEO COMPONENTE 2 MTS <u>4.50</u>	
					
2521 CABO DIN MINI + DIN MINI 1,80MTS CONT.OURO <u>1.70</u>		5673 BIP 2 X 20 X 1,50MTS PT (0,50MM) ENC. <u>2.00</u>		1180 CABO 3RCA + 3RCA 1.80MT GOLD <u>4.00</u>	
		5674 BIP 2 X 20 X 1,80MTS PT (0,50MM) ENC. <u>2.30</u>			
1172 CABO F + BALOON CHAVEADO SAÍDA 75/300R HMS MILFRA <u>3.70</u>				1182 CABO 3RCA + 3RCA 2.00MT C/ COAXIAL EMBORRAC. <u>8.00</u>	<b>CABO COAXIAL EMBORRACHADO</b>
		6703 BIP 2 X 20 X 2,00MTS PT (0,75MM) <u>2.60</u>			
2213 CABO F + RCA 2,00MTS INJETADO <u>1.50</u>				3165 AZ AZUL <u>9.80</u>	
		6178 FERRO PASSAR S/BUCHA PT TERM.TIPO ENCAIXE <u>5.00</u>		3165 VD VERDE <u>9.80</u>	
1006 CABO P2 + P2 STEREO 1,5MTS <u>2.30</u>		9469 FERRO PASSAR S/BUCHA CZ TERM.TIPO ENCAIXE <u>5.00</u>		3165 VM VERMELHO <u>9.80</u>	
				3165 PT PRETO <u>9.80</u>	
		8156 TELEFONE/CELULAR/DISKMAN <u>5.50</u>			
				1179 CABO PLUG ACENDEDOR PARA P4 2MT <u>3.40</u>	
					
				4082 AZ AZUL <u>1.90</u>	





2 RCA MACHO + 1 RCA FÊMEA  
4081 PT PRETO 1.90



**CABO CHATO P/ TELEFONE 4V (ROLO COM 300 METROS)**  
9554 BRANCO 90.00  
9555 CINZA 90.00  
9556 PRETO 90.00



**ROLO COM 100 METROS**  
CABO COAXIAL P/ TV RGC59  
1030 45% BRANCO 56.00  
CABO COAXIAL P/ TV RGC59  
1011 67% BRANCO 74.00  
CABO COAXIAL P/ TV RGC6  
1029 67% BRANCO 102.00



**ROLO COM 100 METROS**  
1023 FIO BICOLOR 2X22 46.00  
1024 FIO BICOLOR 2X20 (0.5MM) 52.00  
1025 FIO BICOLOR 2X18 (0.75MM) 75.00  
1028 FIO BICOLOR 2X16 (1.00MM) 106.00  
FIO BICOLOR 2X18 (0.75MM) -  
1107 CRISTAL 75.00

**CABOS FLAT (MÍN. 20 UN POR REFERÊNCIA)**

CABO FLAT CONEC/SOQUETE  
7941 12VIAS X 12,0CM X 1,25MM 0.40  
CABO FLAT BLINDAGEM ALUMÍNIO 7VIAS X 22,0CM X 1,00MM 1.40

**CONTATO COMUM**

7933	3 X 7,0CM X 1,25MM	0.18
8228	5 X 21,0CM X 1,25MM	0.60
5125	5 X 24,0CM X 1,25MM	0.30
7453	6 X 9,0CM X 1,00MM	0.20
6063	6 X 10,0CM X 1,25MM	0.23
7454	6 X 14,0CM X 1,25MM	0.25
7935	6 X 26,0CM X 1,25MM	0.25
7937	6 X 34,5CM X 1,25MM	0.38
4770	6 X 44,0CM X 1,25MM	0.55
7938	7 X 9,0CM X 1,25MM	0.20
7939	7 X 10,5CM X 1,25MM	0.25
6064	7 X 11,0CM X 1,25MM	0.33
3862	7 X 12,0CM X 1,25MM	0.38
3113	7 X 15,0CM X 1,25MM	0.30
7925	7 X 22,0CM X 1,25MM	0.35
7456	7 X 27,0CM X 1,25MM	0.40
7973	7 X 34,0CM X 1,25MM	0.40
7926	8 X 12,0CM X 1,00MM	0.23
8572	8 X 17,8CM X 1,25MM	0.30
5644	8 X 31,0CM X 1,25MM	0.38
5126	9 X 10,0CM X 1,25MM	0.19
3241	9 X 13,0CM X 1,25MM	0.23

8143	9 X 18,0CM X 1,25MM	0.23
7940	9 X 19,0CM X 1,25MM	0.44
5127	9 X 23,0CM X 1,25MM	0.38
5128	9 X 40,0CM X 1,25MM	0.55
7457	9 X 51,0CM X 1,25MM	0.95
4219	10 X 17,0CM X 1,25MM	0.28
4771	10 X 32,0CM X 1,25MM	0.43
7458	10 X 57,0CM X 1,00MM	0.73
8145	11 X 12,0CM X 1,00MM	0.20
6637	11 X 13,0CM X 1,25MM	0.20
4772	11 X 22,0CM X 1,25MM	0.30
5129	11 X 23,0CM X 1,25MM	0.43
2961	11 X 25,0CM X 1,25MM	0.70
7459	12 X 10,0CM X 1,25MM	0.23
6638	12 X 11,0CM X 1,25MM	0.23
7941	12 X 12,0CM X 1,25MM	0.40
8146	12 X 15,5CM X 1,25MM	0.23
8148	12 X 20,0CM X 1,25MM	0.30
6139	12 X 33,5CM X 1,25MM	0.48
7460	12 X 36,0CM X 1,00MM	0.65
6917	12 X 52,0CM X 1,25MM	0.48
7461	12 X 70,5CM X 1,25MM	0.75
8724	12 X 74,5CM X 1,25MM	1.60
7462	13 X 11,0CM X 1,25MM	0.28
7463	13 X 13,0CM X 1,00MM	0.28
6141	13 X 19,5CM X 1,00MM	0.30
6142	13 X 24,5CM X 1,25MM	0.70
6143	13 X 26,0CM X 1,25MM	0.40
3515	13 X 34,0CM X 1,25MM	0.48
7977	14 X 15,0CM X 1,25MM	0.60
7464	14 X 103,0CM X 1,25MM	2.50
5131	15 X 7,0CM X 1,00MM	0.20
6803	15 X 8,0CM X 1,00MM	0.25
5132	15 X 9,0CM X 1,00MM	0.30
9082	15 X 9,5CM X 1,25MM	0.40
6804	15 X 10,0CM X 1,00MM	0.30
7465	15 X 11,0CM X 1,00MM	0.30
6918	15 X 16,0CM X 1,25MM	0.45
2960	15 X 20,0CM X 1,25MM	0.48
6805	15 X 27,0CM X 1,00MM	0.45
8674	15 X 49,7CM X 1,25MM	0.80
7467	16 X 11,0CM X 1,00MM	0.25
5646	16 X 15,0CM X 1,00MM	0.50
6919	16 X 24,0CM X 1,00MM	0.50
6639	16 X 33,0CM X 1,00MM	0.90
8727	16 X 91,0CM X 1,25MM	2.00
5133	17 X 14,0CM X 1,25MM	0.30
8149	17 X 23,0CM X 1,25MM	0.43
5134	17 X 31,0CM X 1,25MM	0.65
6640	18 X 16,0CM X 1,25MM	0.38
7927	18 X 28,0CM X 1,00MM	0.60
6920	19 X 18,5CM X 1,00MM	0.45
5135	19 X 23,0CM X 1,25MM	0.55
4221	19 X 32,0CM X 1,00MM	0.55
7942	19 X 32,0CM X 1,25MM	1.10
4011	19 X 41,0CM X 1,00MM	1.55
8728	19 X 59,3CM X 1,00MM	2.10
2703	20 X 13,0CM X 1,25MM	0.38
3872	20 X 21,0CM X 1,25MM	0.55
6921	20 X 24,0CM X 1,25MM	0.60
6641	20 X 32,0CM X 1,25MM	1.00
8152	21 X 55,0CM X 1,25MM	0.40
7471	22 X 10,5CM X 1,00MM	0.50
3472	23 X 10,0CM X 1,00MM	0.45
3873	23 X 17,0CM X 1,25MM	1.35
5136	23 X 20,0CM X 1,25MM	1.15
5137	23 X 26,0CM X 1,25MM	1.35
8947	24 X 8,5CM X 0,50MM	0.40
9007	24 X 12,0CM X 0,50MM	0.45
8948	24 X 15,0CM X 0,50MM	0.40
6642	25 X 16,0CM X 1,00MM	0.80
7944	25 X 21,0CM X 1,25MM	0.90
6922	25 X 23,0CM X 1,25MM	0.60
9010	26 X 20,0CM X 0,50MM	0.43
2739	26 X 20,0CM X 1,00MM	0.60
8153	26 X 28,0CM X 1,25MM	1.25
8733	26 X 30,0CM X 0,50MM	1.20
8154	27 X 26,0CM X 1,25MM	1.35

6923	28 X 9,0CM X 0,50MM	0.40
8575	28 X 16,0CM X 0,50MM	0.43
6806	29 X 13,0CM X 1,25MM	0.55
6144	29 X 30,0CM X 1,25MM	0.55
7475	30 X 8,0CM X 1,00MM	0.45
8577	30 X 9,0CM X 0,50MM	0.50
8675	30 X 18,2CM X 0,50MM	0.63
9163	30 X 24,0CM X 0,50MM	0.65
6807	31 X 16,0CM X 1,25MM	0.63
8155	33 X 23,0CM X 1,25MM	1.15

**CONTATO INVERTIDO**

6345	4 X 25,0CM X 1,25MM	0.55
7452	4 X 34,5CM X 1,25MM	0.35
7934	6 X 23,0CM X 1,25MM	0.38
7971	6 X 28,0CM X 1,25MM	0.45
7936	6 X 32,0CM X 1,25MM	0.33
7455	7 X 8,0CM X 1,25MM	0.28
7972	7 X 14,0CM X 1,25MM	0.40
7974	8 X 46,0CM X 1,25MM	0.70
8142	8 X 55,0CM X 1,25MM	0.55
6065	9 X 5,0CM X 1,25MM	0.18
8144	10 X 10,0CM X 1,25MM	0.28
7941	12 X 12,0CM X 1,25MM	0.40
8147	12 X 15,5CM X 1,25MM	0.45
7975	13 X 14,0CM X 1,25MM	0.30
7976	13 X 22,0CM X 1,25MM	0.55
8578	13 X 27,0CM X 1,25MM	0.63
5130	14 X 16,0CM X 1,25MM	0.65
7978	14 X 23,0CM X 1,25MM	0.75
7979	14 X 28,0CM X 1,25MM	0.80
5617	14 X 31,0CM X 1,25MM	0.55
5618	14 X 51,0CM X 1,25MM	0.73
8725	15 X 7,5CM X 1,00MM	0.33
7980	15 X 10,0CM X 1,25MM	0.45
7466	15 X 20,0CM X 1,25MM	0.40
4774	16 X 13,0CM X 1,00MM	0.35
5619	16 X 15,0CM X 1,25MM	0.40
5620	16 X 25,0CM X 1,25MM	0.48
5621	18 X 21,0CM X 1,25MM	0.60
5622	18 X 41,0CM X 1,25MM	0.80
7468	19 X 17,0CM X 1,25MM	0.65
7981	19 X 21,0CM X 1,25MM	0.68
7928	20 X 20,0CM X 1,25MM	0.75
7470	20 X 40,0CM X 1,25MM	1.65
9160	22 X 23,0CM X 0,50MM	0.60
7943	22 X 37,0CM X 1,00MM	0.60
7473	23 X 15,5CM X 1,25MM	0.55
8229	23 X 24,0CM X 1,00MM	1.15
8230	23 X 28,0CM X 1,00MM	1.25
9161	24 X 5,5CM X 0,50MM	0.35
8573	24 X 6,7CM X 0,50MM	0.38
9162	24 X 8,5CM X 0,50MM	0.40
8729	24 X 12,0CM X 1,00MM	0.30
7474	24 X 12,0CM X 1,00MM	0.43
9009	24 X 20,0CM X 0,50MM	1.10
8732	24 X 24,0CM X 0,50MM	0.43
9011	26 X 20,0CM X 0,50MM	0.50
8576	29 X 10,0CM X 0,50MM	0.35

**CABO FLEXÍVEL POLIAMIDA**

7016	AIWA/PIONNER 8 X 63,0MM	1.00
6192	AIWA/PIONNER 8 X 65,0MM	1.00
7591	AIWA/PIONNER 8 X 75,0MM	1.20
9013	AIWA/PIONNER 8 X 79,0MM	1.13
6194	AIWA/PIONNER 8 X 85,0MM	0.90

6343	GRADIENTE 10 VIAS	1.30
7587	KENWOOD 13 VIAS	2.55
7588	KENWOOD 13 VIAS	3.20
7140	KENWOOD 13 VIAS X 150MM	3.48
7590	KENWOOD 15VIAS X 130MM	3.05
8231	KENWOOD 22VIAS X 110MM	7.50
9026	KENWOOD 32VIAS X 24VIAS	5.50
9014	PIONNER 12 VIAS	2.25
9019	PIONNER 16 VIAS	2.55
9022	PIONNER 18 VIAS X 9 VIAS	2.45
9023	PIONNER 22 VIAS X 38 VIAS	1.83
6196	PIONNER 26 VIAS X 152MM	4.50
9016	SONY 14 VIAS X 75MM	0.88
9020	SONY 18 VIAS X 70MM	0.75

## CARREGADOR



1211 CARREGADOR ADAPTADOR  
100 - 240V AC PARA USB 5V 1A 13.00



1212 CARREGADOR VEICULAR USB  
5V 9.00

## CAPAS



1586 CAPA CONECTOR DB09/VGA15 1.10



3463 CAPA CONECTOR DB09/VGA15  
C/KIT RETENÇÃO 1.20



8313 CAPA CONECTOR DB15 C/KIT  
RETENÇÃO LONGO 1.40



3464 CAPA CONECTOR DB25 C/KIT  
RETENÇÃO 1.90



8312 CAPA PLUG BNC N KM1  
BORRACHA PRETA 0.60



8311 CAPA PLUG CLIMPAR  
RG6/RG59 BORRACHA PRETA 0.60

## CONECTORES



6185 ADAP. I ADUK SLIM DB 25 X DB  
25 MACHO 6.60



3465 CONECTOR DB09 FÊMEA  
P/SOLDA 0.70



3466 CONECTOR DB09 MACHO  
P/SOLDA 0.70



8320 CONECTOR DB15 FÊMEA  
P/SOLDA 0.55



8321 CONECTOR DB15 MACHO  
P/SOLDA 0.55



8322 CONECTOR VGA15 FÊMEA  
P/SOLDA 0.85



8323 CONECTOR VGA15 MACHO  
P/SOLDA 0.80



1207 CONECTOR DB25 FÊMEA  
P/SOLDA 0.80



1206 CONECTOR DB25 MACHO  
P/SOLDA 1.10

## DIVISORES



1732 DIVISOR BLINDADO 75Ω 1 IN X  
2 OUT 2.60



1204 DIVISOR BLINDADO 75R 1 IN X  
2 OUT 900/2400MHZ 4.10



1733 DIVISOR BLINDADO 75Ω 1 IN X  
3 OUT 1.90



1734 DIVISOR BLINDADO 75Ω 1 IN X  
4 OUT 2.00



6206 DIVISOR DE ÁUDIO 1 IN X 2  
OUT 11.00

## CHAVE SELETORA



1003 CHAVE SELETORA 3  
ENTRADAS X 1 SAÍDA 14.00

## CHAVES



1227 CHAVE ON/OFF 4 TERMINAIS  
6A 250V 4.30



1226 CHAVE ON/OFF/ON 6  
TERMINAIS 10A 250V 4.50



1234 CHAVE ON/OFF TV TOSHIBA  
KDC-A02-1 - 5A/80V 250V 5.00



4865 ON/OFF C/CHAVE 1.15



4937 UNIP.ON/OFF 6A 125V 3A  
250VAC KNH 1S 2.40



2591 UNIPOLAR ON/OFF 2  
POSIÇÕES 1.20



2126 PT PRETA 1.10

2126 VM VERMELHA 1.10



9054 PT PRETA 0.60

9054 VM VERMELHA 0.60

9054 VD VERDE 0.60



1052 CHAVE POWER ON/OFF 6A  
250V KCD1-106 PRETA 1.90



5330 ON/OFF 2 POLOS C/SUPORTE 1.60



7947 ON/OFF 2 POLOS C/SUPORTE 1.50



3946 ON/OFF 2 POLOS C/SUPORTE  
EVETRON 0.70



3845 ON/OFF 2 POLOS C/SUPORTE  
EVETRON 1.80



2818 ON/OFF 2 POLOS C/SUPORTE  
SUPERIOR 2.00



7502 ON/OFF 2 POLOS C/SUPORTE  
TOSHIBA 1.90



7481 ON/OFF 2 POLOS S/SUPORTE 1.10



3846 ON/OFF BIPOLAR PHILIPS 1.70



5657 ON/OFF BIPOLAR PHILIPS 1.60



5270 ON/OFF BIPOLAR PHILIPS KT3  
CTO 2.65



6238 ON/OFF BIPOLAR PHILIPS PT 1.80



1080 CHAVE HH MINI 110/220V 0.40



1081 CHAVE HH GRANDE 110/220V 0.70

	7776 HOR.3 TERM. 3X9MM	2.00		2009 CHAVE MICRO SWITCH LAMINA	0.45		1683 PUSH BOTTON 6 TERM.C/TRAVA SUJ100201	0.60		5928 4 TERM.6MMX6MM KNOB 4,3MM SMD	0.25
	1763 HOR.3 TERM.TOCA-FITAS	0.60		3342 CHAVE MICRO SWITCH LAMINA NA	0.30		7115 L/D PS22E10 6 TERM.8MM C/TRAVA	0.25		1187 4 TERM.6MMX6MM KNOB 5MM	0.10
	8737 HOR.16 TERM.ALAV.10MM SK42 H02 G10	0.80		4924 12A 1/2HP 125/250VAC DA7 6/1 N027	2.30		1935 MANUAL A+B P/ANTENA	2.40		6403 4 TERM.6MMX6MM KNOB 7MM	0.10
	8735 HOR.16 TERM.ALAV.6MM SK42 H02 G6	0.60		4921 12A 1/2HP 125/250VAC DA7 6/1 N042	1.15		1621 PT PRETA	0.80		4118 4 TERM.6MMX6MM KNOB 12MM	0.10
	8579 HOR.8 TERM.ALAV.5MM SK23 D44 G5K	0.60		8463 0,1A/125VAC C/ALAVANCA 40MM C X 4MM L	1.50		9056 VM CHAVE PUSH BOTTON DS 612 3 TERM. VM	3.40		4183 4 TERM.6MMX6MM KNOB 19MM	0.12
	8739 HOR.16 TERM.ALAV.11MM SK43 D01 M12	0.60		4920 12A 1/2HP 125/250VAC DA7 6/1-NC	1.15		1213 CHAVE PUSH BOTTON NA 8A 125V/ 4A 250V	3.60		7137 4 TERM.7,5MMX7,5MM KNOB 5MM	0.30
	8741 HOR.16 TERM.ALAV.15MM SK43 D03 G15S	0.60		5328 15A 1/2HP 125/250VAC	3.60		5926 2 TERM.3MMX6MM KNOB 5MM SMD	0.35		6419 4 TERM.12MMX12MM KNOB 4MM	0.25
	8743 VERT.16 TERM.ALAV.9MM SS43 D01 G9	0.60		5329 15A 1/2HP 125/250VAC RESISTENTE À UMIDADE	8.90		8461 2 TERM.3MMX6MM KNOB 5MM SMD	0.20		7790 2 TERMINAIS 5MM KNOB 4.3MM	0.20
	8745 VERT.16 TERM.ALAV.11MM SS43 D01 M10	0.60		8161 NA 16A 1/2HP 125/250VAC NA	0.90		4067 2 TERM.6MMX6MM KNOB 4,3MM	0.17		7792 2 TERMINAIS 5MM KNOB 3MM	0.18
				8161 NF C16A 1/2HP 125/250VAC NF	0.90		7135 2 TERM.6MMX6MM KNOB 7MM	0.12		8996 2 TERM.5MM KNOB 9.5MM	0.15
				2593 ON/OFF C/ TRAVA 2 POLOS	0.35		6075 2 TERM.7,5MMX7,5MM KNOB 5MM	0.30		8369 2 TERM.3,5MMX7MM KNOB 4,3MM	0.24
				3938 TECLA FUNÇÕES C/3 CHAVES	0.20		8318 4 TERM.5,2MMX5,2MM KNOB 1,6MM	0.50		1195 2 TERM.6MMX6MM KNOB 4,3MM	0.15
				1883 8CH SUV082A02B 15MM ENTRE TECLAS	2.00		8319 4 TERM.6MMX6MM KNOB 3,1MM SMD	0.10		8358 2 TERM.6MMX6MM KNOB 5MM FIX.10MM	0.15
				7131 ON/OFF 3 TERM.C/TRAVA	0.20		1196 4 TERM.6MMX6MM KNOB 4,3MM	0.10		6417 2 TERM.6MMX6MM KNOB 6MM FIX.13MM	0.15



	2 TERM.6MMX6MM KNOB FIX.13MM	<u>0.15</u>
-----------------------------------------------------------------------------------	---------------------------------	-------------

	2 TERM.6MMX6MM KNOB 9,5MM	<u>0.12</u>
-----------------------------------------------------------------------------------	------------------------------	-------------

	2 TERM.6MMX6MM KNOB 11,85MM FIX.10MM	<u>0.15</u>
-----------------------------------------------------------------------------------	-----------------------------------------	-------------

	2 TERM.6MMX6MM KNOB 11,35MM FIX.7MM	<u>0.15</u>
-----------------------------------------------------------------------------------	----------------------------------------	-------------

	2 TERM.6MMX6MM KNOB 13,85MM FIX.13MM	<u>0.15</u>
-----------------------------------------------------------------------------------	-----------------------------------------	-------------

	2 TERM.6MMX6MM KNOB 13MM FIX.13MM	<u>0.15</u>
-----------------------------------------------------------------------------------	--------------------------------------	-------------

	4 TERM.2 CHAVES EBQQBH05S	<u>0.50</u>
------------------------------------------------------------------------------------	---------------------------	-------------

	4 TERM.2 CHAVES EVQQBH09S	<u>0.30</u>
-------------------------------------------------------------------------------------	---------------------------	-------------

	4 TERM.2 CHAVES EVQQBH18S	<u>0.30</u>
-------------------------------------------------------------------------------------	---------------------------	-------------

**COOLERS/ VENTUINHAS**

	VENTUINHA 40X40X10 MM 12V	<u>6.00</u>
-------------------------------------------------------------------------------------	---------------------------	-------------

	VENTUINHA 60X60X25 12V	<u>6.50</u>
-------------------------------------------------------------------------------------	------------------------	-------------

	VENTUINHA 80X80X25 12V	<u>5.80</u>
-----------------------------------------------------------------------------------	------------------------	-------------

	VENTUINHA 120X120X38 12V	<u>19.00</u>
	VENTUINHA 120X120X38 BIVOLT	<u>20.00</u>

**CHOQUE MICRO INDUTOR**

	1201-2 1,8UH	<u>0.12</u>
	1201-4 3,3UH	<u>0.12</u>
	1201-5 4,7UH	<u>0.12</u>
	1201-6 6,8UH	<u>0.12</u>
	1201-9 15UH	<u>0.12</u>
	1201-10 18UH	<u>0.12</u>
	1201-11 22UH	<u>0.12</u>
	1201-13 39UH	<u>0.12</u>
	1201-14 47UH	<u>0.12</u>
	1201-15 56UH	<u>0.12</u>
	1201-16 68UH	<u>0.12</u>
	1201-18 180UH	<u>0.12</u>
	1201-19 220UH	<u>0.12</u>
	1201-20 330UH	<u>0.12</u>
	1201-22 1000UH	<u>0.12</u>

	4970 180UH	<u>0.12</u>
-------------------------------------------------------------------------------------	------------	-------------

**CRISTAL**

CRISTAL P/ CONTROLE REMOTO  
("QTDE. MÍNIMA: 20 PCS")

	CRISTAL A	
	1210 3,575.611MHZ	<u>0.80</u>
	3354 4,500MHZ	<u>1.20</u>
	2462 17,430MHZ	<u>1.20</u>

	CRISTAL B	
	8069 10,7MHZ 3 TERMINAIS	<u>0.30</u>
	8100 364MHZ 2 TERMINAIS	<u>0.50</u>
	5616 393MHZ 2 TERMINAIS	<u>0.35</u>
	5331 420MHZ 2 TERMINAIS	<u>0.35</u>
	5332 425MHZ 2 TERMINAIS	<u>0.35</u>
	8556 429MHZ 2 TERMINAIS	<u>0.30</u>
	1221 450MHZ 2 TERMINAIS	<u>0.30</u>
	2831 450MHZ 3 TERMINAIS	<u>0.40</u>
	2596 455MHZ 2 TERMINAIS	<u>0.20</u>
	1219 455MHZ 3 TERMINAIS	<u>0.35</u>
	1220 485MHZ 2 TERMINAIS	<u>0.30</u>
	6010 660MHZ 2 TERMINAIS	<u>0.30</u>

**DIODOS**

	3321 DIODO BA220 IBRAPE	<u>0.03</u>
	6474 12KVA AXIAL ESJC-01-12BX	<u>3.30</u>
	6649 BCR16HM10L (16AX1KV)	<u>4.00</u>

	ESM740-CH=STY7406	
3312	VERT.TV.TFK = STY 7406	<u>1.70</u>

3273	IN5062 (2AX800V)=SKF4F2/08	<u>1.00</u>
------	----------------------------	-------------

	3280 LED 3MM AM	<u>0.12</u>
	3281 LED 3MM VD	<u>0.12</u>
	3282 LED 3MM VM	<u>0.12</u>
	3284 LED 5MM AM	<u>0.15</u>
	3285 LED 5MM VD	<u>0.15</u>
	3286 LED 5MM VM	<u>0.15</u>
	9073 LED 5MM TRANSP AZ 15.000MCD (MILICANDELA)	<u>0.60</u>
	9074 LED 5MM TRANSP BR 11.000MCD (MILICANDELA)	<u>0.55</u>
	9075 LED 5MM TRANSP VM 1.800MCD (MILICANDELA)	<u>0.60</u>

	LED PISCA TRICOLOR (AZ/VD/VM) 3.6V/ 3000MCD	<u>1.00</u>
1102		
1103	LED PISCA VERMELHO 3V LED TRANSPARENTE AMARELO 12000MCD	<u>0.80</u>
1104		<u>0.60</u>

	3318 SKB 25/04 (25AX400V)	<u>3.90</u>
	6909 SKB 35/10 (35AX1KV)	<u>5.00</u>
	3295 6A8 (6AX800V)	<u>0.50</u>
	3296 6A10 (6AX1000V)	<u>0.50</u>
	8630 BYV28-200/20-3,5A/200V	<u>0.90</u>
	7920 BYV95A/SK4F2/02	<u>1.00</u>
	3272 BYW54=SKF4F2/06	<u>1.00</u>
	8412 BYW98/200	<u>0.75</u>
	3803 D3L20 ENCAP.TO220	<u>0.60</u>
	7074 IN4007 (MILHEIRO)	<u>55.00</u>
	3278 IN4007 (CENTO)	<u>5.50</u>
	3299 DIODO IN5408-3A/800V	<u>0.25</u>
	3300 DIODO SK1/04=SKE1/04	<u>0.50</u>
	3304 DIODO	<u>0.60</u>
	3279 DIODO IN4148 (CENTO)	<u>2.20</u>

	3306 2V2 ZENER 2V2 1/2W	<u>0.10</u>
	3306 2V4 ZENER 2V4 1/2W	<u>0.10</u>
	3306 2V7 ZENER 2V7 1/2W	<u>0.10</u>
	3306 3V3 ZENER 3V3 1/2W	<u>0.10</u>
	3306 3V6 ZENER 3V6 1/2W	<u>0.10</u>
	3306 3V9 ZENER 3V9 1/2W	<u>0.10</u>
	3306 4V3 ZENER 4V3 1/2W	<u>0.10</u>
	3306 4V7 ZENER 4V7 1/2W	<u>0.10</u>
	3306 5V1 ZENER 5V1 1/2W	<u>0.10</u>
	3306 5V6 ZENER 5V6 1/2W	<u>0.10</u>
	3306 6V2 ZENER 6V2 1/2W	<u>0.10</u>
	3306 6V8 ZENER 6V8 1/2W	<u>0.10</u>
	3306 7V5 ZENER 7V5 1/2W	<u>0.10</u>
	3306 8V2 ZENER 8V2 1/2W	<u>0.10</u>
	3306 9V1 ZENER 9V1 1/2W	<u>0.10</u>
	3306 10V ZENER 10V 1/2W	<u>0.10</u>
	3306 11V ZENER 11V 1/2W	<u>0.10</u>
	3306 12V ZENER 12V 1/2W	<u>0.10</u>
	3306 15V ZENER 15V 1/2W	<u>0.10</u>
	3306 16V ZENER 16V 1/2W	<u>0.10</u>
	3306 18V ZENER 18V 1/2W	<u>0.10</u>
	3306 20V ZENER 20V 1/2W	<u>0.10</u>
	3306 22V ZENER 22V 1/2W	<u>0.10</u>
	3306 24V ZENER 24V 1/2W	<u>0.10</u>
	3306 27V ZENER 27V 1/2W	<u>0.10</u>
	3306 30V ZENER 30V 1/2W	<u>0.10</u>

	3306 36V ZENER 36V 1/2W	<u>0.10</u>
	3306 39V ZENER 39V 1/2W	<u>0.10</u>
	3307 3V9 ZENER 3V9 1W	<u>0.15</u>
	3306 43V ZENER 43V 1/2W	<u>0.10</u>
	3306 47V ZENER 47V 1/2W	<u>0.10</u>
	3306 51V ZENER 51V 1/2W	<u>0.10</u>
	3306 75V ZENER 75V 1/2W	<u>0.10</u>
	3307 3V3 ZENER 3V3 1W	<u>0.15</u>
	3307 4V3 ZENER 4V3 1W	<u>0.15</u>
	3307 4V7 ZENER 4V7 1W	<u>0.15</u>
	3307 5V6 ZENER 5V6 1W	<u>0.15</u>
	3307 6V2 ZENER 6V2 1W	<u>0.15</u>
	3307 6V8 ZENER 6V8 1W	<u>0.15</u>
	3307 7V5 ZENER 7V5 1W	<u>0.15</u>
	3307 8V2 ZENER 8V2 1W	<u>0.15</u>
	3307 9V1 ZENER 9V1 1W	<u>0.15</u>
	3307 10V ZENER 10V 1W	<u>0.15</u>
	3307 12V ZENER 12V 1W	<u>0.15</u>
	3307 13V ZENER 13V 1W	<u>0.15</u>
	3307 15V ZENER 15V 1W	<u>0.15</u>
	3307 16V ZENER 16V 1W	<u>0.15</u>
	3307 20V ZENER 20V 1W	<u>0.15</u>
	3307 22V ZENER 22V 1W	<u>0.15</u>
	3307 30V ZENER 30V 1W	<u>0.15</u>
	3307 33V ZENER 33V 1W	<u>0.15</u>
	3307 3V6 ZENER 3V6 1W	<u>0.15</u>
	3307 47V ZENER 47V 1W	<u>0.15</u>
	3307 51V ZENER 51V 1W	<u>0.15</u>
	3307 56V ZENER 56V 1W	<u>0.15</u>
	3307 62V ZENER 62V 1W	<u>0.15</u>
	3307 68V ZENER 68V 1W	<u>0.15</u>

**SUPORTE PARA LED**

	SUPORTE P/LED ROSCA 3MM CROMADO	<u>0.73</u>
--------------------------------------------------------------------------------------	------------------------------------	-------------

	SUPORTE P/LED ROSCA 3MM CROMADO	<u>0.20</u>
---------------------------------------------------------------------------------------	------------------------------------	-------------

	SUPORTE P/LED ROSCA 3MM PRETO	<u>0.40</u>
---------------------------------------------------------------------------------------	----------------------------------	-------------

	SUPORTE P/LED ROSCA 3MM PRETO (MÍN 10PÇS)	<u>0.20</u>
---------------------------------------------------------------------------------------	----------------------------------------------	-------------

	SUPORTE P/LED ROSCA 5MM CROMADO	<u>0.72</u>
---------------------------------------------------------------------------------------	------------------------------------	-------------

	SUPORTE P/LED ROSCA 5MM CROMADO	<u>0.20</u>
---------------------------------------------------------------------------------------	------------------------------------	-------------

	SUPORTE P/LED ROSCA 5MM PRETO	<u>0.54</u>
---------------------------------------------------------------------------------------	----------------------------------	-------------

## FERRAMENTAS

	ALICATE DE BICO LONGO 150MM	<b>4.40</b>
	ALICATE DECAPADOR UNIVERSAL JFA22	<b>5.50</b>
	ALICATE DESCASCA/CORTA HT1091	<b>11.00</b>
	FERRO DE SOLDA ZD200N 220V/30W	<b>10.50</b>
	FERRO DE SOLDA ZD200N 220V/40W	<b>12.00</b>
	FERRO DE SOLDA ZD200C 220V/60W	<b>14.40</b>
	ALICATE DE CLIMPAR RJ-45	<b>29.00</b>
	ALICATE DE COMPRESSAO RG-6	<b>32.00</b>
	PINCA RETA PONTA CHATA TW0104 TS13	<b>3.60</b>
	PINCA RETA PONTA FINA TW0101 TS10	<b>3.60</b>
	PINCA RETA PONTA FINA TW0102 TS11	<b>3.60</b>
	PINCA RETA PONTA FINA TW0103 TS12	<b>3.60</b>

	PINCA RETA PONTA FINA TW0105 TS14	<b>3.60</b>
	PISTOLA DE COLA 7MM 11-30W 110-240V	<b>13.00</b>



## FONTES

	FORTE UNIVERSAL 1600mA AC/DC C/ 6 ADAPTADORES 3- 4,5-5-6-7,5-8,4-9-12V MOD PST- 1600M	<b>35.00</b>
	12VDC 110/220V 500MA C/PLUG P4 P/ TEL.S/ FIO/ETC	<b>9.90</b>
	4,5V X 500MA 110/220V	<b>14.50</b>
	7,5V X 500MA 110/220V	<b>14.50</b>
	FORTE 5V/ 1A BIVOLT	<b>13.00</b>
	FORTE 9V/ 500MA BIVOLT	<b>11.00</b>
	FORTE 9V/ 1A BIVOLT	<b>13.00</b>
	FORTE 9V/ 2A BIVOLT	<b>20.00</b>
	FORTE 12V/ 1A BIVOLT	<b>13.00</b>
	FORTE 12V/ 2A BIVOLT	<b>20.00</b>
	FORTE CHAVEADA COM LED 12V 5A	<b>40.00</b>









1202	FORTE CHAVEADA P/ CFTV 12V 10A	<b>82.00</b>
------	-----------------------------------	--------------

## FUSÍVEIS

	FUSÍVEIS DE CERÂMICA	
2499	8A	<b>0.13</b>
2484	10A	<b>0.13</b>
5984	12A	<b>0.13</b>
2532	15A	<b>0.25</b>
2538	20A	<b>0.25</b>
	FUSÍVEL VIDRO GRANDE 3 AG (100MA ATÉ 30A) -CENTO	<b>8.40</b>
	FUSÍVEL VIDRO PEQUENO 3 AG (100MA ATÉ 30A) -CENTO	<b>10.00</b>

## FUSÍVEIS TÉRMICOS

	10A 250VAC 215/216° (MÍN 10 PÇS)	<b>0.60</b>
	10A 250VAC 229° (MÍN 10 PÇS)	<b>0.60</b>
	10A 250VAC 245/250° (MÍN 10 PÇS)	<b>0.60</b>
	1105 10A 120° (MÍN. 10 PÇS)	<b>0.60</b>
	1106 10A 102° (MÍN. 10 PÇS)	<b>0.60</b>
	FUSÍVEL TÉRMICO 15A 250VAC 150C	<b>0.35</b>
	FUSÍVELS PHILIPS	
8042	FUSIVEL PHILIPS 0,100A	<b>0.70</b>
1695	FUSIVEL PHILIPS 0,315A	<b>0.70</b>
3826	FUSIVEL PHILIPS 0,400A	<b>0.70</b>
9040	FUSIVEL PHILIPS 0,500A	<b>0.70</b>
9041	FUSIVEL PHILIPS 0,630A	<b>0.70</b>
3827	FUSIVEL PHILIPS 0,800A	<b>0.70</b>
2971	FUSIVEL PHILIPS 1A	<b>0.70</b>
9042	FUSIVEL PHILIPS 1,25A	<b>0.70</b>
1735	FUSIVEL PHILIPS 1,60A	<b>0.70</b>
2970	FUSIVEL PHILIPS 3,15A	<b>0.70</b>
2969	FUSIVEL PHILIPS 5A	<b>0.70</b>

## PORTA FUSÍVEL

	PORTA FUSÍVEL 20AG AÉREO C/FIO PARA AUTO RÁDIO, TOCA CD'S (MIN.10PCS)	<b>0.40</b>
	3AG PAINEL PRETO (MIN.10PCS)	<b>0.90</b>
	3AG PAINEL VERMELHO (MIN.10PCS)	<b>0.90</b>
	GARRA JACARE 37MM	
2578 PT	MOD.170 ISOLADA PRETO	<b>0.35</b>
2578 VM	MOD.170 ISOLADA VERMELHA	<b>0.35</b>
	40 MM MOD GJ705 ISOLADA ("QTDE MÍNIMA: 10 PCS")	
3573 PT	PRETA	<b>0.80</b>
3573 VM	VERMELHA	<b>0.80</b>
	43 MM MOD 171 ISOLADA ("QTDE MÍNIMA: 20 PCS")	
6037 PT	PRETA	<b>0.20</b>
6037 VM	VERMELHA	<b>0.20</b>
	53 MM MOD 172 ISOLADA ("QTDE MÍNIMA: 20 PCS")	
6039 PT	PRETA	<b>0.23</b>
6039 VM	VERMELHA	<b>0.23</b>
	57 MM MOD. GB112 ISOLADA ("QTDE MÍNIMA: 10 PCS")	
3574 PT	PRETA	<b>0.90</b>
3574 VM	VERMELHA	<b>0.90</b>
	GARRA JACARE 70MM ISOLADA PRETO	<b>0.50</b>
1090 PT	GARRA JACARE 70MM ISOLADA VERMELHA	<b>0.50</b>



1173 PT GARRA JACARE 105MM 100A PRETA 1.60

1173 VM GARRA JACARE 105MM 100A VERMELHA 1.60



1175 PT GARRA JACARE 135MM 300A PRETA 4.80

1175 VM GARRA JACARE 135MM 300A VERMELHA 4.80



GARRA JACARE P/ BATERIA JUMBO 4" TOTAL. ISOLADA

9170 VM VERMELHA 1.30

9170 PT PRETA 1.30



50MM MOD 511 MEIA ISOLÇÃO P/ BATERIA ("QTDE MÍNIMA: 10 PCS")

6041 PT PRETA 0.50

6041 VM VERMELHA 0.50



75MM MOD 511 MEIA ISOLÇÃO P/ BATERIA ("QTDE MÍNIMA: 10 PCS")

1612 PT PRETA 0.50

1612 VM VERMELHA 0.50

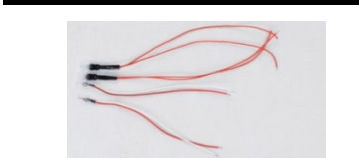

QUANTIDADE MÍNIMA: 20PCS

4893 12V X 3MM 0.35

7800 12V X 5MM 0.35



QUANTIDADE MÍNIMA: 20PCS

1340 6V VERDE 3MM 0.20

1341 6V VERDE 4MM 0.20

7951 12V BRANCA 4MM 0.20

4896 12V VERDE 3MM 0.20

2997 12V VERDE 4MM 0.20

8633 12V AMARELA 3MM 0.20

8635 12V AZUL 3MM 0.20

8637 12V VERMELHA 3MM 0.20

**LOCALIZADOR DE SATÉLITE**



1215 LOCALIZADOR DE SATÉLITE ANALÓGICO 950 A 2050 Mhz 25.00

**MICROFONES**



1071 CONJUNTO DE MICROFONES PRATA/PRETO (PLÁSTICO) 39.00

**MOTOR COMUM**



9494 MOTOR 5,9V EIXO DVD E PLAYSTATION MOTOR 5,9V 5MM EIXO DVD E PLAYSTATION 3.70

9495 MOTOR 5,9V 6MM EIXO DVD E PLAYSTATION 3.70

9172 MOTOR 5,9V 8,5MM EIXO DVD E PLAYSTATION 3.70

**MULTÍMETROS**



1216 MULTIMETRO ANALOGICO YX360TR 25.00



1704 MULTIMETRO DIGITAL DT830B 17.00

**PONTAS DE PROVA**



1620 PT PT0953 PRETA 1.60

1620 VM PT0953 VERMELHA 1.60



3881 PT PT0958 PRETA 0.65

3881 VM PT0958 VERMELHO 0.65



3991 PONTA DE PROVA PINO FINO PP58162BBS 3.30



1616 PONTA DE PROVA PINO FINO MOD.5262 4.90



1618 PONTA DE PROVA PINO FINO MOD.5362 5.10



1617 PONTA DE PROVA PINO GROSSO MOD.5385 6.80



7100 ZD200N 30W 2.30

7617 ZD200N 40W 2.30

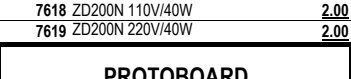

7101 ZD200N 110V/30W 2.00

7102 ZD200N 220V/30W 2.00

7618 ZD200N 110V/40W 2.00

7619 ZD200N 220V/40W 2.00

**PROTOBOARD**



1002 PROTOBOARD 1360 PINOS 55.00



1101 PROTOBOARD 1680 PINOS 65.00

**RELÉS**

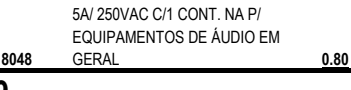

8048 RELÉ ALKS321 A02-DC12V X 5A/ 250VAC C/1 CONT. NA P/ EQUIPAMENTOS DE ÁUDIO EM GERAL 0.80



7817 RELÉ VS12MB 12VDC X 10A/ 250VAC C/1 CONT. NA MOMENTÂNEO P/ USO GERAL 1.00

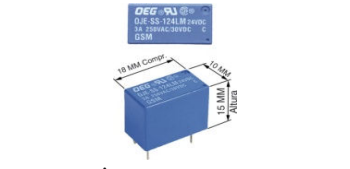

8425 RELÉ OJE-SS-124LM 24VDC X 3A/250 VAC C/ 1 CONTATO MOMENTÂNEO 0.90



4765 RELÉ REED TIPO AMPOLA RI 12 C/15MM CONTATO NA 1.00



5050 RELE 12VDC 10A 1 CONTATO JQC 3F 2.00

**SOLDAS**



8656 SOLDA AZUL 60X40 CARRETEL 1,0MM X 250GR 27.00



8657 SOLDA AZUL 60X40 CARRETEL 1,0MM X 500GR 53.00



9115 SOLDA AZUL 60X37 TUBINHO 1MMX25GR 4.60

**SUGADORES DE SOLDA**

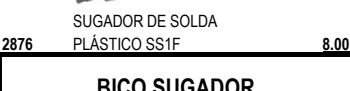

4931 SUGADOR DE SOLDA METÁLICO YL6 7.80



2876 SUGADOR DE SOLDA PLÁSTICO SS1F 8.00



5530 BICO DE REPOSIÇÃO P/SUGADOR SOLDA ELÉTRICO 30W-110V/220V 1.10



**SUPORTE FERRO SOLDA**



SUPORTE FERRO DE SOLDA  
C/ESPONJA VEGETAL

6097 6.20

**GRAXA SILICONE**



1778 GRAXA SILICONE 50GR 18.20



LUBRIFICANTE AEROSOL  
SILICONE 250G/400ML  
IMPLASTEC

4197 13.80



**EXTENSAO TELEBRAS PLUG LATAO MACHO X  
PLUG FÊMEA 5 METROS**

2217 BG	BEGE	2.00
2217 BR	BRANCO	2.00
2217 CZ	CINZA	2.00
2217 PT	PRETO	2.00

**PRODUTOS ORBI**



LIMPA CONTATOS 300ML/  
209GR AEROSOL ORBI

1049 12.00

**LIMPA CONTATOS**



LIMPA CONTATO AEROSOL  
120GR/ 150ML IMPLASTEC

4040 39.00



LUBRIFICANTE GRAFITE 15GR

2897 2.40

**EXTENSAO TELEBRAS PLUG LATÃO MACHO X  
PLUG FÊMEA 10 METROS**

2218 BG	BEGE	4.00
2218 BR	BRANCO	4.00
2218 CZ	CINZA	4.00



WHITE LUB 300ML/ 209GR  
AEROSOL ORBI

1050 8.50



LIMPA CONTATO AEROSOL  
130GR 210ML IMPLASTEC

8911 15.50



PASTA TERMICA LATA 15GR  
IMPLASTEC

1627 2.90

**EXTENSAO 4 CONTATOS FONE/FAX DE 2 LINHAS 2  
MTS**

1258 BG	BEGE	0.75
1258 BR	BRANCO	0.75
1258 CZ	CINZA	0.75
1258 GL	GELO	0.75
1258 PT	PRETO	0.75



**EXTENSAO PARA MONOFONE**

8639	2MTS BEGE	0.50
8640	2MTS BRANCO	0.50
8641	2MTS CINZA CLARO	0.50
8642	2MTS CINZA MÉDIO	0.50
8643	2MTS CINZA CHUMBO	0.50
8644	2MTS MARROM	0.50
8646	3MTS BEGE	0.70
8647	3MTS BRANCO	0.70
8648	3MTS CINZA CLARO	0.70
8649	3MTS CINZA MÉDIO	0.70
8650	3MTS CINZA CHUMBO	0.70
8651	3MTS MARROM	0.70

**ÁLCOOL ISOPROPÍLICO**



A.ISOPROPILICO 110ML C/BICO  
APLICADOR

4038 5.20



LIMPA CONTATO AEROSOL  
120GR/ 150ML IMPLASTEC

8912 35.70



PASTA TERMICA BISNAGA  
10GR IMPLASTEC

1027 3.00

PASTA TERMICA BISNAGA  
50GR IMPLASTEC

1628 11.00



PASTA TERMICA POTE 50GR  
IMPLASTEC

4201 9.90



A.ISOPROPILICO 250ML

2678 10.60

A.ISOPROPILICO 500ML

6935 18.00



LIMPA CONTATO AEROSOL  
217GR/ 210ML IMPLASTEC

4041 36.00



PERCLORETO 250GR  
IMPLASTEC

4199 16.00

PERCLORETO 500GR  
IMPLASTEC

4200 27.00

**VARISTOR**



VARISTOR KB265

2557 0.10

**TELEFONIA - ACESSÓRIOS**



CÂPSULA MAGNÉTICA BR  
TELEFONE/FAX

8457 0.70

**EXTENSAO FONE/FAX DE 1 LINHA 1.5 METRO**

8502 BG	BEGE	1.60
8502 BR	BRANCO	1.60
8502 CZ	CINZA	3.20
8502 PT	PRETO	3.20



**EXTENSAO FONE/FAX DE 1 LINHA 1.5 METRO**

7330 BR	BRANCO	1.00
---------	--------	------



**EXTENSAO FONE/FAX DE 1 LINHA 9 METROS MOD  
757**

8503 BG	BEGE	2.00
8503 CZ	CINZA	2.00

**EXTENSAO FONE/FAX DE 2 LINHAS 9 METROS  
MOD 797/2**

8504 BG	BEGE	2.30
8504 CZ	CINZA	2.30

## ADAPTADOR MODULAR



### 1 LINHA "BLISTADO" MOD 2707/2

3215 BG	BEGE	0.80
3215 BR	BRANCO	0.80
3215 CZ	CINZA	0.80
3215 PT	PRETO	0.80

### 2 LINHAS "BLISTADO" MOD 2703/2

3214 BG	BEGE	0.80
3214 BR	BRANCO	0.80
3214 CZ	CINZA	0.80
3214 PT	PRETO	0.80



### 2 LINHAS 4 CONTATOS MOD PN-03D

6479 BR	BRANCO	0.60
---------	--------	------



FÊMEA DUPLA ATÉ 2  
EXT.MOD.731 PRETA

6322		1.00
------	--	------



### FÊMEA PADRÃO/ FÊMEA MODULAR "BLISTADO" MOD 577

3210 BG	BEGE	0.70
3210 BR	BRANCO	0.70
3210 CZ	CINZA	0.70
3210 PT	PRETO	0.70



### TEL/FAX/SECR.ELETR. 4 CONTATOS MOD. 2751/2

1058 CZ	CINZA	0.60
---------	-------	------



### TELEBRÁS/ USA MOD 747/801

2637 BG	BEGE	0.80
2637 BR	BRANCO	0.80
2637 CZ	CINZA	0.80



### TELEBRÁS/ USA PINO LATÃO MOD PN05B

1669 BG	BEGE	0.60
1669 BR	BRANCO	0.60
1669 CZ	CINZA	0.60



### TELEBRÁS/ USA PINO LATÃO MOD PN-2700

5981 BG	BEGE	0.50
5981 BR	BRANCO	0.50
5981 CZ	CINZA	0.50



### EMBUTIR 2 LINHAS COM ESPELHO MOD. 800/2

3211 BG	BEGE	1.30
3211 CZ	CINZA	1.30



### EMBUTIR 6 CONTATOS KS MOD.756/3

3212 BG	BEGE	0.60
3212 BR	BRANCO	0.60
3212 CZ	CINZA	0.60



### EMBUTIR 8 CONTATOS KS MOD.785

3213 BG	BEGE	1.20
3213 BR	BRANCO	1.20
3213 CZ	CINZA	1.20
3213 CR	CROMADO	1.20
3213 PT	PRETO	1.20

## BUCHAS TEFLON



1608	BUCHA TEFLON TOZZU (CENTO)	15.00
------	-------------------------------	-------



1609	BUCHA TEFLON TO3 (CENTO)	15.00
------	--------------------------	-------



1700	MICA ISOLANTE TO3 (MIN.100PCS)	0.20
------	-----------------------------------	------



1699	MICA ISOLANTE TO220 (MIN.100PCS)	0.20
------	-------------------------------------	------



4194	MICA ISOLANTE TO92 (MIN.100PCS)	0.25
------	------------------------------------	------

## TRIMMER MURATA



4909	6,8 A 45PF AMARELO	0.75
4905	2 A 7PF AZUL	0.75
4911	3 A 11PF BRANCO	0.75
4910	9,8 A 60PF MARROM	0.75
4912	4,2 A 20PF ROSA	0.75
4908	5,2 A 30PF VERDE	0.75

## COLA



8024	COLA SILICONE BR 180ML	4.00
------	------------------------	------

## FIXA CABOS MIGUELÃO



### FIXA CABOS MIGUELÃO

9033	7MM (CENTO)	4.00
9034	7MM (MILHEIRO)	36.00
9035	8MM (CENTO)	4.10
9036	8MM (MILHEIRO)	37.00
9037	10MM (CENTO)	8.00
9038	10 MM (MILHEIRO)	60.00

## MINI POTENCIÔMETRO



1190	POTENCIOMETRO MINI 500KB	0.80
------	--------------------------	------

## POTENCIÔMETROS



POTENCIÔMETRO SPIKA C/ 3 TERMINAIS E C/  
KNOB, UTILIZADO EM VOLUME DE RADIOS E  
WALKMANS. DISPONÍVEL NOS SEGUINTES  
VALORES:

4721	B20K	0.80
4722	B50K	0.80
4723	B100K	0.80



POTENC. SPIKA B50K C/ 4  
TERMINAIS C/KNOB,  
UTILIZADO EM VOLUME DE  
WALKMAN E DISCMAN

6853		1.00
------	--	------



POTENCIÔMETRO SPIKA C/ 5 TERMINAIS E C/  
KNOB, UTILIZADO EM VOLUME DE WALKMANS E  
DISKMANS. DISPONÍVEL NOS SEGUINTES  
VALORES:

4724	B20K	1.15
4725	B50K	1.15
4726	B100K	1.15



POTENC.LINEAR 50KB LINEAR  
C/ ROSCA, EIXO MÉDIO  
ESTRIADO SOLDA FIO

1857		1.80
------	--	------



POTENCIÔMETRO LINEAR, EIXO MÉDIO ESTRIADO  
P/ ANT PARABÓLICAS E USO GERAL. DISPONÍVEL  
NOS SEGUINTES VALORES:

7606	5KB OHMS	0.90
1896	10KB OHMS	0.90
1893	50KB OHMS	0.90
1895	100KB OHMS	0.90
1897	200KB OHMS	0.90



POTENCIÔMETRO LINEAR, EIXO MÉDIO ESTRIADO.  
DISPONÍVEL NOS SEGUINTES VALORES:

1894	50KB EIXO METÁLICO	0.80
3521	100KB EIXO METÁLICO	0.80



POTENCIÔMETRO TRIMPOT DEITADO  
HORIZONTAL 14MM

1405 150R	1.00
1405 330R	1.00
1405 1K	1.00
1405 2K2	1.00
1405 22K	1.00
1405 1M	1.00
1405 2M2	1.00



POTENCIÔMETRO TRIMPOT EM PÉ VERTICAL  
14MM

1406 220R	1.00
1406 470R	1.00
1406 680R	1.00
1406 1K	1.00
1406 3K3	1.00
1406 10K	1.00
1406 22K	1.00
1406 100K	1.00
1406 220K	1.00
1406 330K	1.00
1406 1M	1.00
1406 1M5	1.00
1406 2M2	1.00
1406 4M7	1.00



POTENCIÔMETRO TRIMPOT MINIATURA,  
DISPONÍVEL NAS VERSÕES HORIZONTAL (H) E  
VERTICAL (V):

1407 330R (HOR)	1.00
1407 1K (HOR)	1.00
1407 2K2 (HOR)	1.00
1407 10K (HOR)	1.00
1407 22K (HOR)	1.00
1407 33K (HOR)	1.00
1407 100K (HOR)	1.00
1407 220K (HOR)	1.00
1407 330K (HOR)	1.00
1407 4M7 (HOR)	1.00
1407 220R (VERT)	1.00
1407 470R (VERT)	1.00
1407 4K7 (VERT)	1.00
1407 20K (VERT)	1.00
1407 100K (VERT)	1.00
1407 220K (VERT)	1.00
1407 470K (VERT)	1.00
1407 2M2 (VERT)	1.00
1407 4M7 (VERT)	1.00



**POTENCIÔMETRO TRIMPOT MINI 7MM HORIZONTAL PARA USO GERAL ("QUANTDE. MÍNIMA: 10 PÇS POR VALOR")**

8810	1K (HOR)	1.00
8811	2K2 (HOR)	1.00
7824	3K3 (HOR)	1.00
8631	4K7 (HOR)	1.00
8812	10K (HOR)	1.00
7825	22K (HOR)	1.00
7827	33K (HOR)	1.00
7891	47K (HOR)	1.00
8813	100K (HOR)	1.00
7828	220K (HOR)	1.00



**POTENCIÔMETRO TRIMPOT MINI 7MM VERTICAL PARA USO GERAL ("QUANTDE. MÍNIMA: 10 PÇS POR VALOR")**

8814	1K (VERT)	1.00
7829	2K2 (VERT)	1.00
8815	3K3 (VERT)	1.00
8816	4K7 (VERT)	1.00
8632	10K (VERT)	1.00
7830	22K (VERT)	1.00
8817	33K (VERT)	1.00
8818	47K (VERT)	1.00
7831	100K (VERT)	1.00
7832	220K (VERT)	1.00

**FORNOS - ACESSÓRIOS**



CABO FORÇA P/ MICROONDAS DIVERSAS MARCAS - COR PRETA

8672		3.50
------	--	------

**CAPACITORES**



7500	0,86UF X 2100VVCA	7.00
8653	0,86UF X 2400VVCA	7.00

**CHAVES**



CHAVE MICRO SWITCH 12A 1/2HP 125/250VAC DA7 6/1-NC

4920		1.15
------	--	------



CHAVE MICRO SWITCH 12A 1/2HP 125/250VAC DA7 6/1 N042

4921		1.15
------	--	------



CHAVE MICRO SWITCH 16A 1/2HP 125/250VAC NA

8161 NA		0.90
---------	--	------

CHAVE MICRO SWITCH 16A 1/2HP 125/250VAC NF

8161 NF		0.90
---------	--	------

**DIODOS**



6649	DIODO BCR16HM10L (16AX1KV)	4.00
------	----------------------------	------

**FUSÍVEIS**



6870	15A 250VAC 150°C	0.35
------	------------------	------

**FUSÍVEIS DE CERÂMICA**



2499	8A	0.13
2484	10A	0.13
5984	12A	0.13
2532	15A	0.25

**MOTORES**

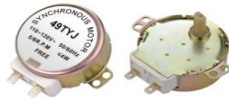

MOTOR 4W 5/6RPM 50/60HZ 110/220V EIXO PLÁSTICO MEIA CANA

9080		10.00
------	--	-------



MOTOR 4W 5/6RPM 50/60HZ 220/240V EIXO PLÁSTICO MEIA CANA

9081		10.00
------	--	-------

**RELÊS**



FORNO MICROONDAS 12VDC YM PL2-12V

7782		1.00
------	--	------



FORNO MICROONDAS 24VDC YM PL2-12V

7786		1.00
------	--	------

**CAPACITOR CERÂMICO (QUANTIDADE MÍNIMA P/ VALOR 100 PÇS)**



3274	1PF	2.60
3274	1,2PF	2.60
3274	1,5PF	2.60
3274	1,8PF	2.60
3274	2,2PF	2.60
3274	2,7PF	2.60
3274	3,3PF	2.60

3274	4,7PF	2.60
3274	5,6PF	2.60
3274	6,8PF	2.60
3274	8,2PF	2.60
3274	10PF	2.60
3274	12PF	2.60
3274	15PF	2.60
3274	18PF	2.60
3274	27PF	2.60
3274	33PF	2.60
3274	39PF	2.60
3274	47PF	2.60
3274	56PF	2.60
3274	62PF	2.60
3274	68PF	2.60
3274	82PF	2.60
3274	120PF	2.60
3274	150PF	2.60
3274	180PF	2.60
3274	220PF	2.60
3274	270PF	2.60
3274	330PF	2.60
3274	390PF	2.60
3274	470PF	2.60
3274	560PF	2.60
3274	680PF	2.60
3274	820PF	2.60
3274	1K	2.60
3274	1K8	2.60
3274	2K2	2.60
3274	2K7	2.60
3274	3K3	2.60
3274	3K9	2.60
3274	4K7	2.60
3275	10K	2.60
5598	22K	2.60
6390	47K	2.60
5599	100K	4.50

**CAPACITOR CERÂMICO DISCO ALTA ISOLAÇÃO**



8079	47PF X 2KV	0.25
8721	100PF X 1KV	0.15
7268	100PF X 2KV	0.13
4740	100PF X 12KV	0.25
8080	150PF X 2KV	0.20
7269	220PF X 1KV	0.12
8081	220PF X 2KV	0.35
7270	330PF X 1KV	0.12
4121	470PF X 500V	0.12
9158	470PF X 3KV	0.40
8082	820PF X 500V	0.12
4123	1K X 500V	0.12
4124	1K X 1KV	0.17
4125	1K X 2KV	0.20
8083	1K X 4KV	0.40
4127	2K2 X 500V	0.12
8624	4K7 X 2KV	0.25

**CAPACITOR CERÂMICO DISCO POLYESTER ESPECIAL**



8621	470PF X 2KV	0.17
799	1K5 X 2KV	0.20
3439	2K2 X 1KV	0.17
8086	2K2 X 2KV	0.20
3440	2K2 X 4KV	0.40
5943	4K7 X 4KV	0.50
4132	10K X 400V	0.30
8626	10K X 500V	0.08
3399	10K X 2KV	0.40

**CAPACITOR POLYESTER**



4122	1K X 400V	0.17
8938	2K2 X 100V	0.05
7633	2K2 X 1600V	0.40
8937	4K7 X 1600V	0.40
843	4K7 X 1600V	0.40
3802	5K5 X 1600V	0.40
801	6K2 X 1600V	0.40
6353	6K8 X 1KV	0.37
6012	6K8 X 1600V	0.60
6355	8K2 X 1KV	0.45
7266	8K2 X 1600V	0.40
8625	9K1 X 1600V	0.60
804	10K X 400V	0.17
6358	10K X 630V	0.50
8939	10K X 1KV	0.55
8941	47K X 100V	0.08
6362	47K X 250V	0.18
8942	68K X 100V	0.08
807	100K X 250V	0.20
808	220K X 250V	0.32
4135	100K X 400V	0.25
808	220K X 250V	0.32
4136	220K X 400V	0.50
844	470K X 250V	0.30
6371	470K X 400V	0.60
6373	680K X 250V	0.77
4138	1M X 250V	0.35
4139	1M X 400V	0.87
809	2M2 X 250V	1.50
4140	2M2 X 400V	1.50
4141	3M3 X 250V	1.50
1231	4M7 X 250V	2.50

**CAPACITOR POLYESTER AXIAL MULTI-CAMADA**

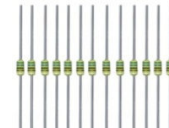



7644	5,6PF X 50V AX (CENTO)	4.00
7645	15PF X 50V AX (CENTO)	4.00
7646	18PF X 50V AX (CENTO)	4.00
7647	33PF X 50V AX (CENTO)	4.00
7648	39PF X 50V AX (CENTO)	4.00
7649	56PF X 50V AX (CENTO)	4.00
7650	82PF X 50V AX (CENTO)	4.00
7651	220PF X 50V AX (CENTO)	4.00
7652	3K3 X 50V AX (CENTO)	5.00
7653	4K7 X 50V AX (CENTO)	5.00
7654	5K X 500V AX (CENTO)	5.00
7655	10K X 50V AX (CENTO)	5.00
7656	22K X 50V AX (CENTO)	5.00
7657	33K X 50V AX (CENTO)	5.00
7658	47K X 50V AX (CENTO)	6.00
7659	100K X 50V AX (CENTO)	7.00

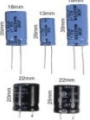

## CAPACITORES ELETROLÍTICOS

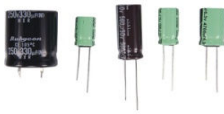

5601	0,10 X 50V RD (4X6)	0.03	711	22 X 250V RD	0.42	8072	220 X 250V RD (25X22) GARRA	4.20	5539	CAPAC.105° 68 X 200V RD (25X16)	0.60
8106	0,10 X 100V RD	0.04	712	22 X 350V RD	0.15	839	220 X 400V RD GARRA	3.60	5073	CAPAC.105° 100 X 35V RD	0.10
8107	0,22 X 50V RD	0.05	6436	22 X 450V RD	1.90	968	270 X 160V RD	0.05	5074	CAPAC.105° 100 X 160V RD	2.10
6431	0,22 X 50V RD (4X7)	0.04	5945	33 X 4V RD (4X5) (MIN.20PCS)	0.06	8073	270 X 160V RD (25X22) GARRA	3.50	3034	CAPAC.105° 100 X 250V RD	2.10
3249	0,22 X 100V RD	0.04	8077	33 X 6,3V RD (5X5) (MIN.20PCS)	0.06	8121	330 X 10V RD (MIN.20PCS)	0.08	5077	CAPAC.105° 100 X 400V RD	3.60
3753	0,33 X 50V (4X7)	0.04	5602	33 X 16V RD (6X8) (MIN.20PCS)	0.05	8122	330 X 16V RD	0.07	5075	CAPAC.105° 120 X 10V RD	0.25
960	0,47 X 50V RD	0.05	962	33 X 16V RD (MIN.20PCS)	0.05	896	330 X 25V RD	0.09	8074	CAPAC.105° 120 X 25V RD	0.30
3263	0,47 X 50V RD	0.03	8078	33 X 25V RD (6X5) (MIN.20PCS)	0.04	985	330 X 35V RD	0.20	7632	CAPAC.105° 120 X 100V RD (21X13)	0.85
884	0,47 X 63V RD	0.05	1956	33 X 25V RD (MIN.20PCS)	0.04	8124	330 X 50V RD	0.18	5076	CAPAC.105° 150 X 10V RD	0.35
678	0,47 X 100V RD	0.04	3047	33 X 50V RD (MIN.20PCS)	0.04	858	330 X 63V RD	0.22	3015	CAPAC.105° 220 X 16V RD	0.10
8075	0,47 X 250V RD	0.20	713	33 X 63V RD (MIN.20PCS)	0.05	6019	330 X 200V RD	2.60	3016	CAPAC.105° 220 X 35V RD	0.20
3754	0,68 X 50V RD (4X7)	0.04	6437	33 X 100V RD	0.18	2775	330 X 400V RD	8.70	5540	CAPAC.105° 220 X 50V RD	0.45
3264	1 X 50V RD (4X7)	0.03	961	33 X 350V RD	2.30	8935	330 X 450V RD (45X30)	9.00	5940	CAPAC.105° 220 X 100V RD	0.90
679	1 X 63V RD	0.06	6293	33 X 450V RD	2.80	8432	390 X 160V RD (39X20)	4.00	7771	CAPAC.105° 330 X 16V RD	0.12
680	1 X 100V RD	0.05	8113	39 X 25V RD (MIN.20PCS)	0.05	8125	470 X 6,3V RD	0.11	5079	CAPAC.105° 330 X 25V RD	0.15
8095	1 X 160V RD	0.07	5603	47 X 6,3V RD (4X7) (MIN.20PCS)	0.06	5948	470 X 6,3V RD (10X9)	0.12	3017	CAPAC.105° 330 X 35V RD	0.28
8109	1 X 200V RD	0.14	5604	47 X 10V RD (5X7) (MIN.20PCS)	0.03	736	470 X 16V RD	0.18	3021	CAPAC.105° 330 X 50V RD	0.42
681	1 X 250V RD	0.12	8114	47 X 10V RD (MIN.20PCS)	0.03	7264	470 X 16V RD (9X8)	0.12	8136	CAPAC.105° 330 X 160V RD	3.80
6013	1 X 350V RD	0.19	3368	47 X 16V RD (6X7) (MIN.20PCS)	0.05	737	470 X 25V RD	0.20	5541	CAPAC.105° 330 X 250V RD	6.00
4145	1 X 450V RD	0.22	715	47 X 25V RD (MIN.20PCS)	0.06	879	470 X 35V RD	0.35	7773	CAPAC.105° 470 X 16V RD	0.10
6014	2,2 X 50V RD	0.04	717	47 X 50V RD (MIN.20PCS)	0.06	3477	470 X 50V RD	0.42	3018	CAPAC.105° 470 X 35V RD	0.38
5647	2,2 X 50V RD (4X7)	0.04	718	47 X 63V RD (MIN.20PCS)	0.07	859	470 X 63V RD	0.56	3022	CAPAC.105° 470 X 50V RD	0.70
682	2,2 X 63V RD	0.06	719	47 X 100V RD	0.25	782	470 X 200V RD	3.30	5941	CAPAC.105° 470 X 200V RD	8.00
683	2,2 X 100V RD	0.05	3370	47 X 200V RD	0.75	783	470 X 250V RD (45X25)	5.00	5080	CAPAC.105° 560 X 50V RD	1.10
8110	2,2 X 160V RD	0.07	849	47 X 250V RD	0.80	773	470 + 330 X 200V RD SHARP	10.00	5081	CAPAC.105° 680 X 10V RD	0.40
830	2,2 X 250V RD	0.15	862	47 X 350V RD	1.40	8126	470 X 385V RD (50X35)	6.50	7265	CAPAC.105° 680 X 16V RD	0.60
749	2,2 X 350V AX	0.23	7768	47 X 385V RD (31,5X18)	1.80	784	470 X 400V RD GARRA	10.00	5082	CAPAC.105° 820 X 16V RD	0.72
684	2,2 X 350V RD	0.20	6015	47 X 400V RD (32X16)	1.80	7806	470 X 400V RD (45X35)	9.00	8715	CAPAC.105° 1000 X 6,3V RD (12X8)	0.20
3045	2,2 X 450V RD (3045)	0.35	7628	47 X 400V RD (30X22) TIPO GARRA	3.70	8127	560 X 100V RD	3.80	5085	CAPAC.105° 1000 X 16V RD (17X10)	0.20
685	3,3 X 50/63V RD	0.04	6438	47 X 450V RD	2.80	8128	560 X 400V RD (50X35)	13.00	5086	CAPAC.105° 1000 X 25V RD	0.40
3357	3,3 X 50V RD (4X7)	0.04	8116	68 X 50V RD	0.16	740	1000 X 16V RD	0.25	5087	CAPAC.105° 1000 X 35V RD	0.60
687	3,3 X 100V RD	0.05	6439	68 X 250V RD (26X16)	0.80	741	1000 X 25V RD	0.50	5088	CAPAC.105° 1200 X 16V RD (16X10)	0.40
840	3,3 X 250V RD	0.14	4146	68 X 400V RD (35X18)	2.60	742	1000 X 50V RD	0.70	8211	CAPAC.105° 1200 X 6,3V RD (12,5X10)	0.20
6435	3,3 X 350V RD	0.28	5065	68 X 400V RD (26X22)	3.00	743	1000 X 63V RD	0.75	8717	CAPAC.105° 1200 X 10V RD (13X10)	0.20
689	3,3 X 450V RD	0.35	4147	82 X 200V RD (26X13)	2.00	6021	1500 X 35V RD	0.80	8212	CAPAC.105° 1500 X 6,3V RD (12,5X10)	0.30
7906	4,7 X 16V RD (4X7)	0.04	4738	82 X 400V RD (26X22)	2.80	8130	1500 X 50V RD	1.30	8718	CAPAC.105° 1500 X 10V RD (16X10)	0.35
3359	4,7 X 35V RD (4X7)	0.03	8713	82 X 420V RD (30X22) GARRA	4.50	7913	2200 X 10V RD	0.32	8213	CAPAC.105° 2200 X 6,3V RD (20X10)	0.40
3360	4,7 X 50V RD (4X7) (MIN.20PCS)	0.03	1959	100 + 100 + 100 X 350V RD	7.00	745	2200 X 16V RD	0.35	8719	CAPAC.105° 2200 X 10V RD (20X10)	0.40
692	4,7 X 50V RD (MIN.20PCS)	0.04	7643	100 X 4V RD (6X5) (MIN.20PCS)	0.06	746	2200 X 25V RD	0.90	9157	CAPAC.105° 2200 X 16V RD (20X13)	0.60
693	4,7 X 63V RD (MIN.20PCS)	0.04	3367	100 X 6,3V RD (5X7) (MIN.20PCS)	0.08	3536	2200 X 35V RD	0.80	3019	CAPAC.105° 2200 X 35V RD	1.60
695	4,7 X 100V RD (MIN.20PCS)	0.05	3740	100 X 10V RD (5X6) (MIN.20PCS)	0.03	3752	2200 X 50V RD	1.30	3023	CAPAC.105° 2200 X 50V RD (20X9)	2.20
696	4,7 X 160V RD	0.15	8117	100 X 10V RD (MIN.20PCS)	0.03	897	3300 X 16V RD	0.55	8828	CAPAC.105° 2700 X 6,3V RD (20X10)	0.40
697	4,7 X 250V RD	0.18	3545	100 X 16V RD (6,3X7) (MIN.20PCS)	0.04	1962	3300 X 25V RD	0.80	8720	CAPAC.105° 3300 X 10V RD (21X13)	0.55
698	4,7 X 350V RD	0.30	721	100 X 16V RD (MIN.20PCS)	0.04	4002	3300 X 35V RD	1.20	3020	CAPAC.105° 3300 X 35V RD	2.40
887	4,7 X 450V RD	0.40	722	100 X 25V RD (MIN.20PCS)	0.05	6022	3300 X 50V RD	1.80	8829	CAPAC.105° 4700 X 6,3V RD (20X12)	0.60
4143	6,8 X 50V RD (4X7) (MIN.20PCS)	0.04	6016	100 X 35V RD (MIN.20PCS)	0.15	6023	3300 X 63V RD	7.00	8830	CAPAC.105° 5600 X 6,3V RD (24X13)	0.65
4795	6,8 X 450V RD	0.70	725	100 X 100V RD	0.80	747	4700 X 16V RD	1.00	3024	CAPAC.105° 4700 X 50V RD	4.90
5944	10 X 6,3V RD (5X5) (MIN.20PCS)	0.03	726	100 X 100 + 50 + 50 X 200V RD	5.00	1964	4700 X 25V RD	1.10	3029	CAPAC.105° 4700 X 100V RD	5.00
6432	10 X 25V RD (4X7) (MIN.20PCS)	0.04	857	100 X 160V RD	0.60	6440	4700 X 35V RD	1.60	<div style="border: 1px solid black; padding: 5px; text-align: center;"> <p><b>CAPACITOR ELETROLÍTICO 105°</b></p>  <p><b>CAPACITOR ELETROLÍTICO BIPOLAR</b></p>  </div>		
4004	10 X 35V RD (4X7) (MIN.20PCS)	0.04	921	100 X 200V RD	1.60	6024	4700 X 50V RD	2.00			
986	10 X 35V RD (MIN.20PCS)	0.04	727	100 X 250V RD	1.60	853	4700 X 63V RD	4.95			
8076	10 X 50V RD (6X5) (MIN.20PCS)	0.03	5537	150 X 10V RD	0.10	8096	6800 X 6,3V RD	0.50			
700	10 X 50V RD (MIN.20PCS)	0.03	987	150 X 25V RD	0.06	8131	6800 X 16V RD	2.90			
701	10 X 63V RD (MIN.20PCS)	0.04	6292	150 X 63V RD	0.48	3048	6800 X 25V RD	2.20			
702	10 X 100V RD (MIN.20PCS)	0.08	7630	150 X 100V RD (20X10)	0.90	8403	8200 X 50 RD (40X30)	8.00			
703	10 X 250V RD	0.24	8429	150 X 315V RD (30X22)	4.00	4003	10000 X 16V RD	6.00			
889	10 X 450V RD	0.60	6347	150 X 400V RD (40X25)	4.80	<div style="border: 1px solid black; padding: 5px; text-align: center;"> <p><b>CAPACITOR ELETROLÍTICO BIPOLAR</b></p> </div>					
3269	22 X 16V RD (4X7) (MIN.20PCS)	0.03	6904	180 X 400V RD (35X25)	5.40						
7908	22 X 16V RD (MIN.20PCS)	0.03	8210	180 X 450V RD (45X25)	5.60				8133	CAPAC.105° 3,3 X 160V RD	0.20
4144	22 X 25V RD (6X7) (MIN.20PCS)	0.03	5947	220 X 4V RD (6X6)	0.10				3032	CAPAC.105° 3,3 X 2500V RD	0.25
705	22 X 25V RD (MIN.20PCS)	0.03	8119	220 X 10V RD (MIN.20PCS)	0.05				7762	CAPAC.105° 6,8 X 350V RD	0.50
5634	22 X 35V RD (5,5X6) (MIN.20PCS)	0.04	7341	220 X 10V RD (8X7)	0.05				7261	CAPAC.105° 6,8 X 400V RD	0.40
7340	22 X 35V RD (MIN.20PCS)	0.04	728	220 X 16V RD (MIN.20PCS)	0.06				3037	CAPAC.105° 10 X 16V RD	0.20
708	22 X 63V RD (MIN.20PCS)	0.07	729	220 X 25V RD (MIN.20PCS)	0.12				5067	CAPAC.105° 10 X 250V RD	0.30
709	22 X 100V RD	0.15	8119	220 X 10V RD (MIN.20PCS)	0.05				7763	CAPAC.105° 22 X 160V RD	0.35
710	22 X 160V RD	0.47	7341	220 X 10V RD (8X7)	0.05				8097	CAPAC.105° 22 X 200V RD	0.60
7764	22 X 200V RD	0.40	5068	220 X 250V RD	0.90	5538	CAPAC.105° 33 X 160V RD	0.90			
			729	220 X 25V RD (MIN.20PCS)	0.12	7765	CAPAC.105° 33 X 200V RD	0.60			
			730	220 X 35V RD	0.14	5069	CAPAC.105° 33 X 250V RD	0.70			
			731	220 X 50V RD	0.16	3033	CAPAC.105° 47 X 250V RD	1.10			
			6017	220 X 100V RD	0.45	5072	CAPAC.105° 47 X 350V RD	3.00			
			7262	220 X 160V RD (35X18)	0.60	7631	CAPAC.105° 47 X 400V RD	1.70			
			8430	220 X 160V RD (25X22)	0.60	5939	CAPAC.105° 56 X 50V RD	0.90			







8009-41	10W X 1K2	<u>0.35</u>
8009-42	10W X 1K5	<u>0.35</u>
8009-43	10W X 1K8	<u>0.35</u>
8009-44	10W X 2K2	<u>0.35</u>
8009-45	10W X 2K7	<u>0.35</u>
8009-46	10W X 3K3	<u>0.35</u>
8009-47	10W X 3K9	<u>0.35</u>
8009-48	10W X 4K7	<u>0.35</u>
8009-49	10W X 5K6	<u>0.35</u>
8009-51	10W X 8K2	<u>0.35</u>
8009-52	10W X 10K	<u>0.35</u>
8009-53	10W X 12K	<u>0.35</u>
8009-54	10W X 15K	<u>0.35</u>
8009-55	10W X 18K	<u>0.35</u>
8009-56	10W X 22K	<u>0.35</u>

### RESISTORES DE FIO CERÂMICA VERDE 10W AXIAL

(MÍN DE 200 PÇS POR VALOR OHMICO)



1421-1	10W X 0,22R	<u>0.35</u>
1421-2	10W X 0,27R	<u>0.35</u>
1421-4	10W X 0,39R	<u>0.35</u>
1421-5	10W X 0,47R	<u>0.35</u>
1421-6	10W X 1R	<u>0.35</u>
1421-7	10W X 1R2	<u>0.35</u>
1421-8	10W X 1R5	<u>0.35</u>
1421-9	10W X 1R8	<u>0.35</u>
1421-10	10W X 2R2	<u>0.35</u>
1421-11	10W X 2R7	<u>0.35</u>
1421-12	10W X 3R3	<u>0.35</u>
1421-13	10W X 3R9	<u>0.35</u>
1421-15	10W X 5R6	<u>0.35</u>
1421-16	10W X 6R8	<u>0.35</u>
1421-17	10W X 8R2	<u>0.35</u>
1421-19	10W X 12R	<u>0.35</u>
1421-21	10W X 18R	<u>0.35</u>
1421-22	10W X 22R	<u>0.35</u>
1421-23	10W X 27R	<u>0.35</u>
1421-24	10W X 33R	<u>0.35</u>
1421-26	10W X 56R	<u>0.35</u>
1421-27	10W X 68R	<u>0.35</u>
1421-28	10W X 82R	<u>0.35</u>
1421-29	10W X 100R	<u>0.35</u>
1421-30	10W X 120R	<u>0.35</u>
1421-31	10W X 150R	<u>0.35</u>
1421-32	10W X 220R	<u>0.35</u>
1421-33	10W X 270R	<u>0.35</u>
1421-34	10W X 330R	<u>0.35</u>
1421-35	10W X 390R	<u>0.35</u>
1421-36	10W X 470R	<u>0.35</u>
1421-37	10W X 560R	<u>0.35</u>
1421-38	10W X 680R	<u>0.35</u>
1421-39	10W X 820R	<u>0.37</u>
1421-40	10W X 1K	<u>0.37</u>
1421-41	10W X 1K2	<u>0.37</u>
1421-42	10W X 1K5	<u>0.37</u>
1421-43	10W X 1K8	<u>0.37</u>
1421-44	10W X 2K2	<u>0.37</u>
1421-45	10W X 2K7	<u>0.37</u>
1421-46	10W X 3K3	<u>0.37</u>
1421-47	10W X 3K9	<u>0.37</u>
1421-48	10W X 4K7	<u>0.37</u>
1421-49	10W X 5K6	<u>0.37</u>
1421-50	10W X 6K8	<u>0.37</u>
1421-51	10W X 8K2	<u>0.37</u>
1421-53	10W X 12K	<u>0.37</u>
1421-54	10W X 15K	<u>0.37</u>
1421-55	10W X 18K	<u>0.37</u>
1421-56	10W X 22K	<u>0.37</u>

### RESISTORES DE FIO ESPECIAIS

(MÍN DE 100 PÇS POR ITEM)



8053	RESISTOR FIO AXIAL 1W X 4R7	<u>0.05</u>
------	-----------------------------	-------------

8054	AXIAL 1W X 68R	<u>0.05</u>
6412	RADIAL 2W X 0,20R	<u>0.08</u>
6377	RADIAL 3W X 0,15R	<u>0.08</u>
8351	RADIAL 3W X 0,22R	<u>0.08</u>
8531	RADIAL 3W X 0,33R	<u>0.08</u>
6413	AXIAL 2W X 2R2	<u>0.08</u>
8056	AXIAL 2W X 3R3	<u>0.08</u>
8530	AXIAL 2W X 4R7	<u>0.08</u>
8057	AXIAL 2W X 12R	<u>0.08</u>
4669	RADIAL 3W X 33R	<u>0.08</u>
8532	RADIAL 3W X 270R	<u>0.08</u>
8058	RADIAL 3W X 1K2	<u>0.08</u>
8533	RADIAL 3W X 10K	<u>0.08</u>
6734	AXIAL 4W X 3R3	<u>0.08</u>

5338	AXIAL 4W X 33R	<u>0.08</u>
6381	AXIAL 5W X 100R	<u>0.20</u>

6414	RADIAL 5W X 0,18R	<u>0.20</u>
6415	RADIAL 5W X 0,20R	<u>0.20</u>
6378	RADIAL 5W X 0,82R	<u>0.20</u>
6735	RADIAL 5W X 1R	<u>0.20</u>
6736	RADIAL 5W X 1R8	<u>0.20</u>
8932	RADIAL 5W X 3R9	<u>0.20</u>
8535	RADIAL 5W X 1K	<u>0.20</u>
8536	RADIAL 5W X 1K2	<u>0.20</u>
2979	RADIAL 5W X 4K7	<u>0.20</u>
6741	RADIAL 5W X 6K8	<u>0.20</u>
6382	RADIAL 5W X 20K	<u>0.20</u>
4752	RADIAL 5W X 56K	<u>0.20</u>
6743	RADIAL 7W X 1R	<u>0.25</u>
7514	RADIAL 7W X 1R5	<u>0.25</u>
7802	RADIAL 7W X 1R8	<u>0.25</u>
7515	RADIAL 7W X 2R2	<u>0.25</u>

7803	RADIAL 7W X 2R2	<u>0.25</u>
7965	RADIAL 7W X 3R3	<u>0.25</u>
6383	RADIAL 7W X 4R7	<u>0.25</u>
6384	RADIAL 7W X 6R8	<u>0.25</u>
7155	RADIAL 7W X 8R2	<u>0.25</u>
5341	AXIAL 7W X 2K2	<u>0.20</u>
5342	AXIAL 11W X 15R	<u>0.50</u>
2894	RADIAL 10W X 820R	<u>0.35</u>
7804	RADIAL 10W X 2R2	<u>0.35</u>
2893	RADIAL 10W X 3R3	<u>0.35</u>
1653	RADIAL 10W X 4R7	<u>0.35</u>
8563	RADIAL 10W X 12R	<u>0.35</u>
5344	RADIAL 10W X 220R	<u>0.35</u>
7348	RADIAL 10W X 4K7	<u>0.35</u>
6385	RADIAL 11W X 180R	<u>0.35</u>
1426	AXIAL 17W X 4R7	<u>0.70</u>
4754	RADIAL 17W X 330R	<u>0.35</u>
1429	AXIAL 20W X 15R VERDE	<u>1.40</u>
1430	AXIAL 20W X 180R	<u>0.75</u>
1431	AXIAL 20W X 200R	<u>0.75</u>
1434	AXIAL 20W X 820R	<u>0.75</u>